

36 607 819



- rosette Ø 60 mm
- head part with cut-to-length spindle and sleeve
- WRAS 2011026, 2010066

	Brushed Bronze	36 607 819-42
	Chrome	36 607 819-00
	Brushed Platinum	36 607 819-06
	Platinum	36 607 819-08
	Dark Chrome	36 607 819-19
	Brushed Durabronze (23kt Gold)	36 607 819-28
	Brushed Champagne (22kt Gold)	36 607 819-46
	Champagne (22kt Gold)	36 607 819-47
	Brushed Dark Platinum	36 607 819-99

36 607 819

mm [inches]

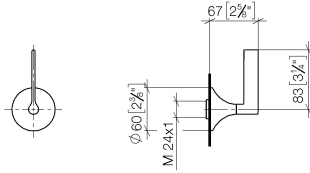

Codes & Standards

DIN 4109	EN 1111	ISO 3822	Scottish Water Byelaws
UK Water Supply Regulations	Ü-Zeichen		

Certificates

WRAS_2010	LGA_29	DVGW_DW- 6512DNO	WRAS_2011
-----------	--------	---------------------	-----------

36 607 819

Parts for other
finishes can be found
here: [Chrome](#)

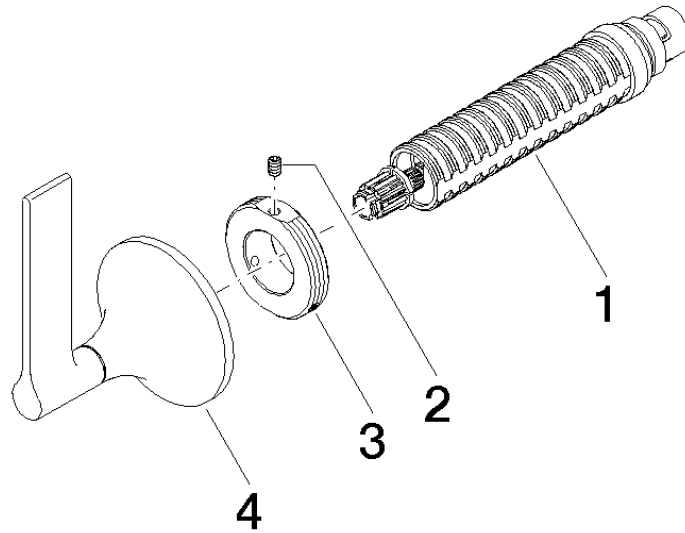



VAIA Wall valve clockwise closing 1/2" - Brushed Bronze

VAIA

36 607 819

Spare parts list

No.	Item Number	Name	Quantity used	Delivery time
	90 90 03 143 00 90	top	4	2