







LISSÉ Wall-mounted single-lever basin mixer without pop-up waste - Matte Black

36 860 845 Product version from 4/1/2024



- 170mm projection
- fixed spout
- circular, air-enriched flow
- hole diameter spout 37 mm
- hole diameter single-lever mixer 57 mm
- rosette 78 x 78 mm
- max. flow 5.7 l/min
- lead-free
- This product can help a building meet the requirements of Green Building Rating Systems, e.g. LEED®, BREEAM®, DGNB
- WRAS

	Matte Black	36 860 845-33
	Chrome	36 860 845-00
	Brushed Platinum	36 860 845-06
	Dark Chrome	36 860 845-19
	Brushed Light Gold	36 860 845-27
	Brushed Chrome	36 860 845-93
	Brushed Dark Platinum	36 860 845-99

Required miscellaneous



Concealed wall-mounted single-lever mixer mixer on right - 35 816 970 90

- NOTE:Not suitable for concealed installation.Connection by means of angle valves, mounted with screws to back wall.

Required miscellaneous



Concealed wall-mounted single-lever mixer - 35 860 970 90

- max. recess depth mm
- min. recess depth mm
- mixer can be placed above, to the left or to the right of the spout.



LISSÉ Wall-mounted single-lever basin mixer without pop-up waste - Matte Black

36 860 845 Product version from 4/1/2024
mm [inches]

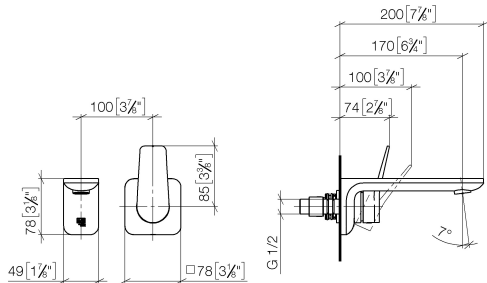

Flow rate chart

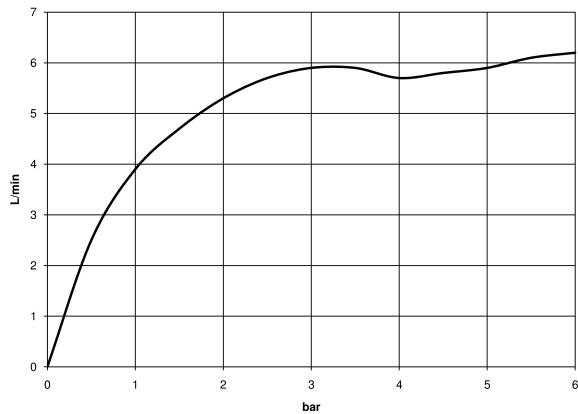

Codes & Standards

EN 817

EPA WaterSense

NSF372

NSF61

Scottish Water
Byelaws

UK Water Supply
Regulations

WaterSense





LISSÉ Wall-mounted single-lever basin mixer without pop-up waste - Matte Black

36 860 845 Product version from 4/1/2024

Certificates

IAPMO_N-4976

DVGW_DW-
6512DN0

IAPMO_6397

WRAS_2107

IAPMO_8834

LISSÉ Wall-mounted single-lever basin mixer without pop-up waste - Matte Black

36 860 845 Product version from 4/1/2024

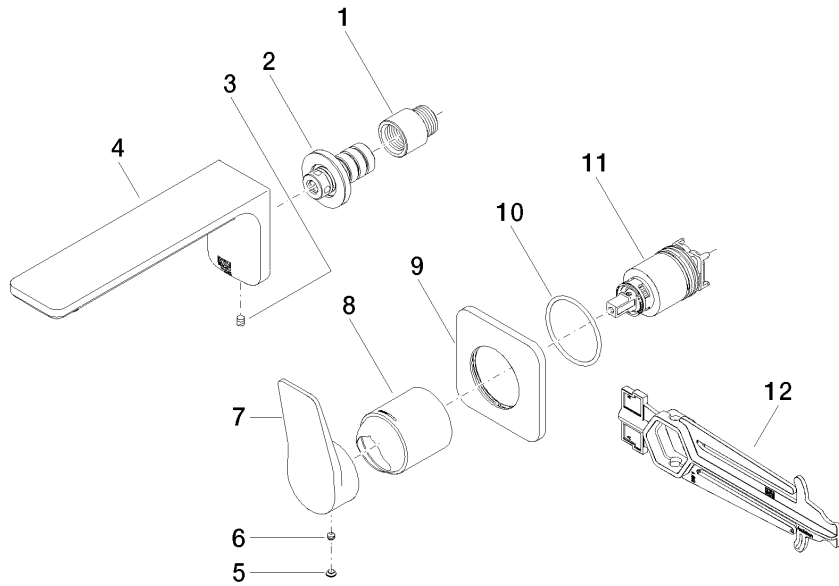

Spare parts list

No.	Item Number	Name	Quantity used	Delivery time
1	09 24 03 072 10 90	nipple	1	2
2	90 24 03 108 00 90	nipple set	1	2
3	90 31 11 004 00 90	pin	1	2
4	90 11 84 021 00-33	spout	1	30
5	90 31 20 087 00-33	plug	1	30
6	90 31 11 063 00 90	pin	1	2
7	09 20 84 021-33	handle	1	30
8	09 11 02 288-33	cover	1	30
9	90 27 84 020 00-33	rosette	1	30
10	90 14 10 049 00 90	seal	1	2
11	90 15 05 046 02 90	cartridge	1	2
12	90 30 09 064 00 90	key	1	2