





## IMO Tissue holder without cover - Chrome

IMO

83 500 670



- width 166mm
- height 60 mm
- 73mm projection

	Chrome	83 500 670-00
	Brushed Platinum	83 500 670-06
	Dark Chrome	83 500 670-19
	Matte Black	83 500 670-33
	Brushed Chrome	83 500 670-93

83 500 670

mm [inches]

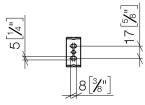
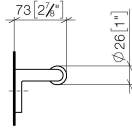
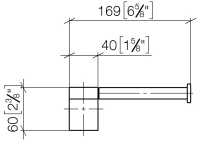

83 500 670

**Product version from 4/1/2024**

Parts for other  
finishes can be found  
here: Brushed  
Platinum

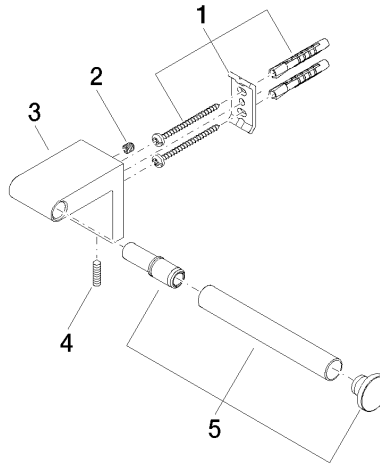



IMO Tissue holder without cover - Chrome

IMO

83 500 670

**Spare parts list**

**Product version from 4/1/2024**

No.	Item Number	Name	Quantity used	Delivery time
	05 17 20 736 00 90	fixing set	5	2