





IMO Tissue holder without cover - Brushed Chrome

IMO

83 500 670



- width 166mm
- height 60 mm
- 73mm projection

	Brushed Chrome	83 500 670-93
	Chrome	83 500 670-00
	Brushed Platinum	83 500 670-06
	Dark Chrome	83 500 670-19
	Matte Black	83 500 670-33

83 500 670

mm [inches]

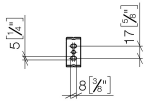
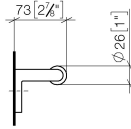
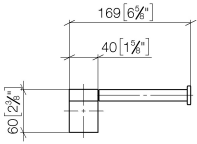

83 500 670

Product version from 4/1/2024

Parts for other
finishes can be found
here: [Chrome](#)

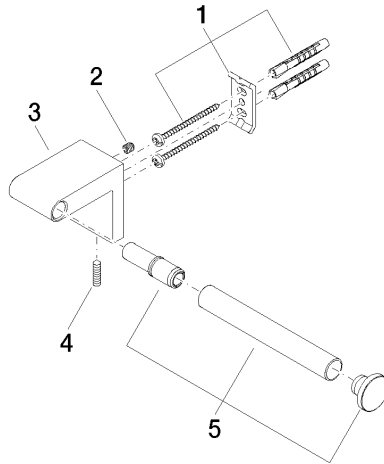



IMO Tissue holder without cover - Brushed Chrome

IMO

83 500 670

Spare parts list

Product version from 4/1/2024

No.	Item Number	Name	Quantity used	Delivery time
	05 17 20 736 00 90	fixing set	5	2