







ST 010 107 7370



- 135mm projection
- fixed spout
- circular, air-enriched flow
- height of mixer 72 mm
- height up to aerator 40 mm
- hole diameter valve 32 mm
- hole diameter spout 35 mm
- without rosette
- 2x 1/2" x 1/2" high pressure hose
- max. flow 7 l/min
- lead-free
- This product can help a building meet the requirements of Green Building Rating Systems, e.g. LEED®, BREEAM®, DGNB

	Brushed Dark Platinum	ST 010 107 7370-99
	Chrome	ST 010 107 7370-00
	Brushed Platinum	ST 010 107 7370-06
	Platinum	ST 010 107 7370-08
	Durabass (23kt Gold)	ST 010 107 7370-09
	Brushed Durabass (23kt Gold)	ST 010 107 7370-28

Individual components of this set

You need the following components for this set

2x 11 170 370-99



1x 20 700 370-99





MADISON Three-hole basin mixer with pop-up waste - Brushed Dark Platinum

MADISON









ST 010 107 7370

ST 010 107 7370

- for basin fittings

NOTE: Mixers are supplied without lever inserts.
Please order the lever inserts separately!



	Brushed Dark Platinum	11 170 370-99
	Chrome	11 170 370-00
	Gold (23.9kt)	11 170 370-01
	Brushed Platinum	11 170 370-06
	Platinum	11 170 370-08
	Durabrand (23kt Gold)	11 170 370-09
	white	11 170 370-12
	black	11 170 370-13
	Brushed Durabrand (23kt Gold)	11 170 370-28

ST 010 107 7370

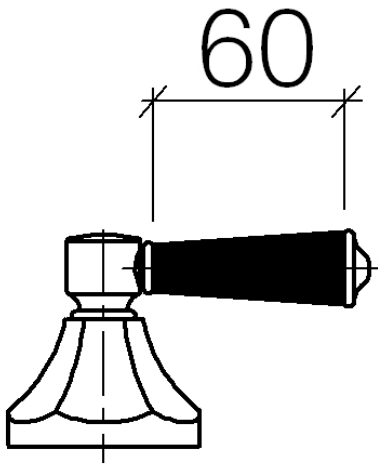





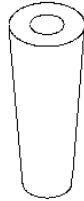

ST 010 107 7370

Parts for other finishes can be found here: [Chrome](#)



- 135mm projection
- fixed spout
- circular, air-enriched flow
- height of mixer 72 mm
- height up to aerator 40 mm
- hole diameter valve 32 mm
- hole diameter spout 35 mm
- without rosette
- 2x 1/2" x 1/2" high pressure hose
- max. flow 7 l/min
- lead-free
- This product can help a building meet the requirements of Green Building Rating Systems, e.g. LEED®, BREEAM®, DGNB

Only suitable for basins with an overflow.

	Brushed Dark Platinum	20 700 370-99
	Chrome	20 700 370-00
	Brushed Platinum	20 700 370-06
	Platinum	20 700 370-08
	Durabress (23kt Gold)	20 700 370-09
	Brushed Durabress (23kt Gold)	20 700 370-28



MADISON Three-hole basin mixer with pop-up waste - Brushed Dark Platinum

MADISON

ST 010 107 7370

ST 010 107 7370

Parts for other finishes can be found here: [Chrome](#)

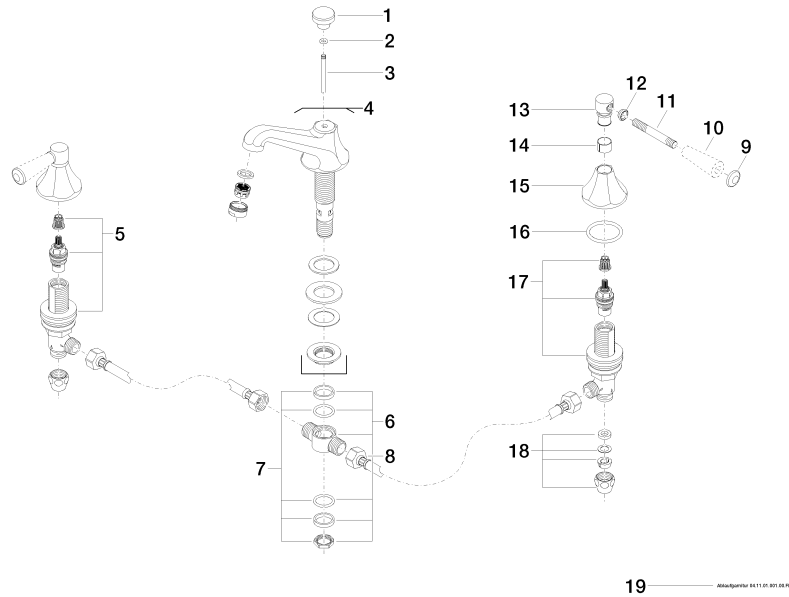

Spare parts list

No.	Item Number	Name	Quantity used	Delivery time
1	09 20 36 030-99	handle	1	30
2	90 14 10 062 00 90	seal	1	2
3	09 31 09 004-99	pull-rod	1	30
4	13 700 380-99	spout	1	30
5	90 17 11 040 51 90	side panel	1	2
6	90 17 11 020 10 90	distributor	1	2
7	90 23 10 012 00 90	gasket kit	1	2
8	04 30 04 096 00 90	hose	2	2
9	09 30 30 062-99	screw	2	30
10	11 170 370-99	MADISON Lever insert - Brushed Dark Platinum	2	30
11	09 28 22 013 90	pipe	2	2
12	09 20 37 001-99	handle	2	30
13	09 20 82 000-99	handle	2	30
14	90 18 40 041 00 90	sleeve	2	2
15	09 27 37 014-99	rosette	2	30
16	90 14 10 043 00 90	seal	2	2
17	90 17 11 040 50 90	side panel	1	2
18	90 23 30 040 00-99	threaded connector	2	30
19	90 11 01 001 00-99	pop-up waste	1	30