







ST 010 201 0705



- 200mm projection
- fixed spout
- rectangular spray pattern with 40 individual jets
- hole diameter valve 35 mm
- hole diameter spout 40 mm
- rosette 60 x 60 mm
- max. flow 4.5 l/min
- lead-free
- This product can help a building meet the requirements of Green Building Rating Systems, e.g. LEED®, BREEAM®, DGNB

	Dark Chrome	ST 010 201 0705-19
	Chrome	ST 010 201 0705-00
	Brushed Platinum	ST 010 201 0705-06
	Brushed Champagne (22kt Gold)	ST 010 201 0705-46
	Champagne (22kt Gold)	ST 010 201 0705-47
	Brushed Dark Platinum	ST 010 201 0705-99

**Individual components of this set**

You need the following components for this set

1x 13 800 705-19



1x 36 607 706-19



1x 36 607 707-19





## CL.1 Wall-mounted basin mixer without pop-up waste - Dark Chrome

---







CL.1

ST 010 201 0705

ST 010 201 0705



- 200mm projection
- fixed spout
- rectangular spray pattern with 40 individual jets
- hole diameter 37 mm
- lead-free
- 1/2" connection
- plug-link mounting
- max. flow 4.5 l/min
- This product can help a building meet the requirements of Green Building Rating Systems, e.g. LEED®, BREEAM®, DGNB

	Dark Chrome	13 800 705-19
	Chrome	13 800 705-00
	Brushed Platinum	13 800 705-06
	Brushed Champagne (22kt Gold)	13 800 705-46
	Champagne (22kt Gold)	13 800 705-47
	Brushed Dark Platinum	13 800 705-99

ST 010 201 0705

mm [inches]

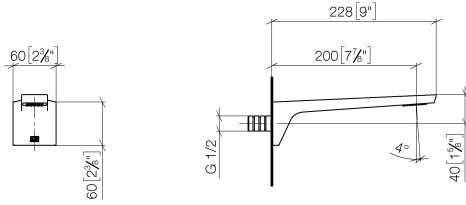

**Flow rate chart**

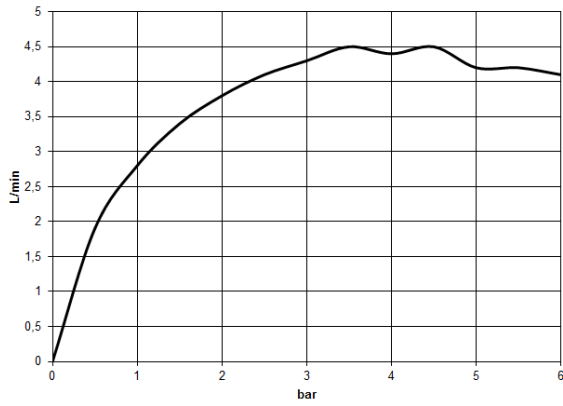

**Certificates**

IAPMO\_N-4976. IAPMO\_6397.

ST 010 201 0705

Parts for other finishes can be found here: [Chrome](#)

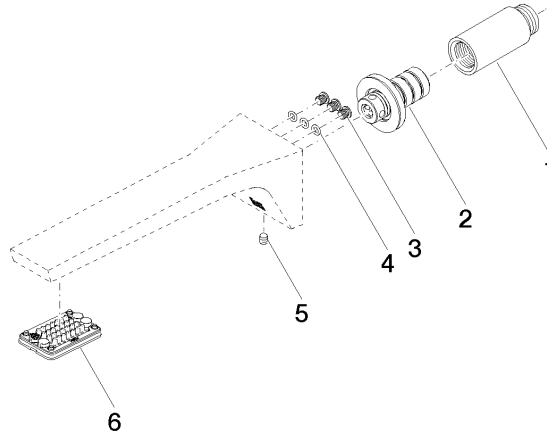







**Spare parts list**

No.	Item Number	Name	Quantity used	Delivery time
1	09 24 03 081 10 90	extension	1	2
2	90 24 03 108 01 90	nipple set	1	2
3	09 30 30 113 20 90	screw	3	2
4	09 14 10 001 90	seal	3	2
5	90 31 11 004 00 90	pin	1	2
6	90 11 02 297 00 90	aerator	1	2

ST 010 201 0705



- rosette 60 x 60 mm
- with cold marking
- head part with cut-to-length spindle and sleeve

	Dark Chrome	36 607 706-19
	Chrome	36 607 706-00
	Brushed Platinum	36 607 706-06
	Brushed Champagne (22kt Gold)	36 607 706-46
	Champagne (22kt Gold)	36 607 706-47
	Brushed Dark Platinum	36 607 706-99

**Required miscellaneous**



- Wall valve 1/2" -** 35 607 970 90
- max. recess depth 150 mm
  - min. recess depth 105 mm



## CL.1 Wall-mounted basin mixer without pop-up waste - Dark Chrome

---

CL.1

ST 010 201 0705

ST 010 201 0705

mm [inches]

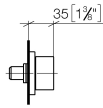
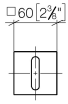

Certificates

LGA\_29931.

WRAS\_2010066.



ST 010 201 0705

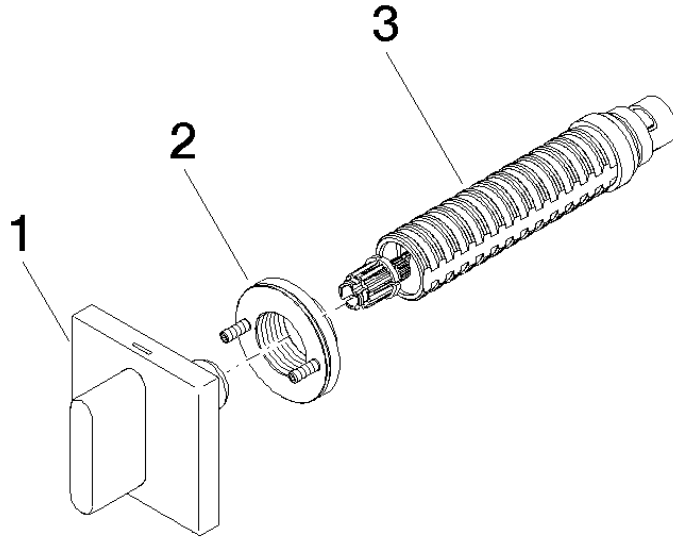







Spare parts list

No.	Item Number	Name	Quantity used	Delivery time
1	90 20 70 051 02-19	handle ( cold )	1	20
2	90 21 02 108 00 90	disc	1	2
3	90 90 03 143 00 90	top	1	2

ST 010 201 0705



- rosette 60 x 60 mm
- with hot marking
- head part with cut-to-length spindle and sleeve

	Dark Chrome	36 607 707-19
	Chrome	36 607 707-00
	Brushed Platinum	36 607 707-06
	Brushed Champagne (22kt Gold)	36 607 707-46
	Champagne (22kt Gold)	36 607 707-47
	Brushed Dark Platinum	36 607 707-99



## CL.1 Wall-mounted basin mixer without pop-up waste - Dark Chrome

---

CL.1

ST 010 201 0705

ST 010 201 0705

mm [inches]

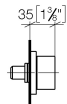
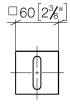

Certificates

LGA\_29931.

WRAS\_2010066.

ST 010 201 0705

Parts for other finishes can be found here: [Chrome](#)

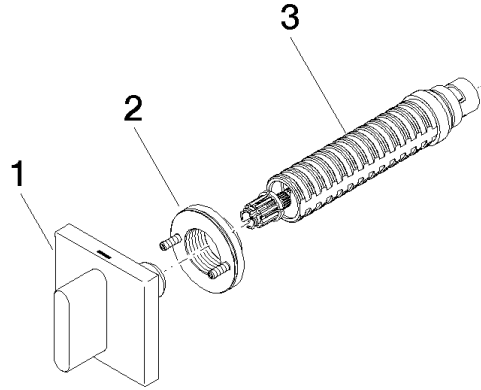

**Spare parts list**

No.	Item Number	Name	Quantity used	Delivery time
1	90 20 70 051 03-19	handle ( hot )	1	20
2	90 21 02 108 00 90	disc	1	2
3	90 90 03 142 00 90	top	1	2