

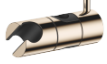













12 580 970

• pour diamètre de tube 18 mm



S'adapte aux gammes suivantes : IMO,
LULU, MADISON, MEM, TARA, CL.1, LISSÉ,
VAIA, META, CYO

	Champagne (Or 22cts)	12 580 970-47
	Chrome	12 580 970-00
	Platine brossé	12 580 970-06
	Platine	12 580 970-08
	Laiton (Or 23cts)	12 580 970-09
	Dark Chrome	12 580 970-19
	Or clair	12 580 970-26
	Or clair brossé	12 580 970-27
	Laiton brossé (Or 23cts)	12 580 970-28
	Noir mat	12 580 970-33
	Bronze brossé	12 580 970-42
	Champagne brossé (Or 22cts)	12 580 970-46
	Chrome brossé	12 580 970-93
	Dark Platinum brossé	12 580 970-99

12 580 970

mm [inches]

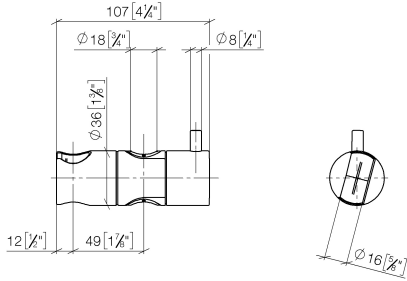

12 580 970

Version du produit de 10/1/2023

Les pièces pour les
autres finitions
peuvent être
trouvées ici : Chrome

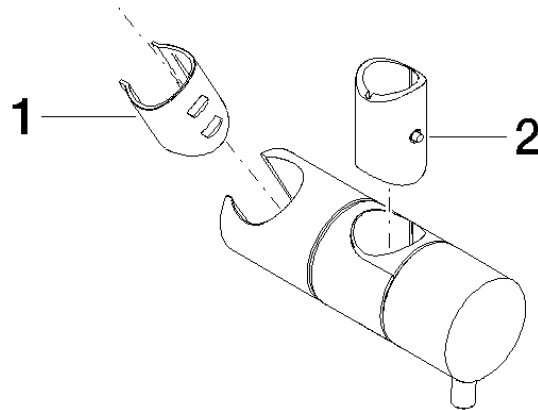



Coulisse - Champagne (Or 22cts)

IMO

12 580 970

Liste des pièces de rechange

Version du produit de 10/1/2023

N°	Article Numéro	Désignation	Fréquence de montage	Délai de livraison
	09 12 12 217 90	douille	2	2