

26 413 979



- barre de douche avec curseur
- diamètre de tube 18 mm
- entraxe 853 mm
- flexible de douche métallique 1750 mm avec protection anti-torsion intégrée
- raccord de flexible de douche 3/8"

Cet article ne comprend pas de douchette à main !

S'adapte aux gammes suivantes : IMO, LULU, MEM, TARA, CL.1, LISSÉ, VAIA, META, CYO

	Chrome	26 413 979-00
	Platine brossé	26 413 979-06
	Platine	26 413 979-08
	Dark Chrome	26 413 979-19
	Or clair	26 413 979-26
	Or clair brossé	26 413 979-27
	Laiton brossé (Or 23cts)	26 413 979-28
	Noir mat	26 413 979-33
	Bronze brossé	26 413 979-42
	Champagne brossé (Or 22cts)	26 413 979-46
	Champagne (Or 22cts)	26 413 979-47
	Chrome brossé	26 413 979-93
	Dark Platinum brossé	26 413 979-99

26 413 979

Accessoires recommandés

	Coude mural à encastrer -	35 085 970 90
	●profondeur de montage max. 163 mm	
	●profondeur de montage mini. 90 mm	

Accessoires recommandés

	LISSÉ Coude mural - Chrome	28 450 845-00
---	-----------------------------------	---------------

Accessoires requis

	Douchette à main FlowReduce - Chrome	28 016 979-00 0010
	●Débit max. 6,8 l/min (à 3 bar)	

Accessoires requis

	Douchette à main FlowReduce - Chrome	28 012 979-00 0010
	●Débit max. 6,8 l/min (à 3 bar)	

Accessoires requis

	Douchette à main - Chrome	28 012 979-00
	●Débit max. 15 l/min (à 3 bar)	

Accessoires requis

	Douchette à main FlowReduce - Chrome	28 018 979-00 0010
	●Débit max. 6,8 l/min (à 3 bar)	

Accessoires recommandés

	Coude mural - Chrome	28 450 980-00
---	-----------------------------	---------------

Accessoires requis

	Douchette à main - Chrome	28 015 979-00
	●Débit max. 15 l/min (à 3 bar)	

Accessoires requis

	Douchette à main - Chrome	28 017 979-00
	●Débit max. 15 l/min (à 3 bar)	

Accessoires requis

	Douchette à main - Chrome	28 016 979-00
	●Débit max. 15 l/min (à 3 bar)	

Accessoires requis

	Douchette à main - Chrome	28 018 979-00
	●Débit max. 15 l/min (à 3 bar)	

26 413 979

mm [inches]

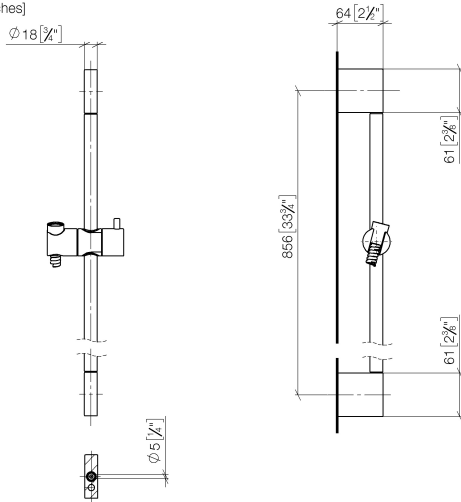

Certificats

WRAS_2009048. ACS_20 ACC LY 738. IAPMO_4976 (1).

26 413 979

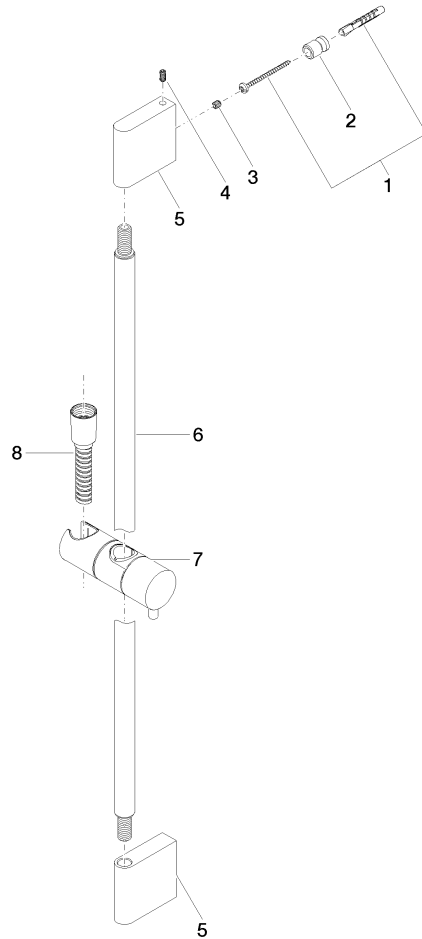

Liste des pièces de rechange

N°	Article Numéro	Désignation	Fréquence de montage	Délai de livraison
1	05 17 20 726 02 90	set de fixation	2	2
2	08 17 20 726 90	patte de fixation	2	2
3	09 31 11 049 90	tige	2	2
4	04 31 11 113 00 90	tige	2	2
5	08 17 97 054-00	patte de fixation	2	10
6	90 28 22 597 00-00	patte de fixation	1	10
7	12 580 970-00	Coulisse - Chrome	1	10
8	28 322 970-00	Flexible métallique de douche 1/2" x 3/8" x 1750 mm - Chrome	1	2