

33 500 882



- saillie 137 mm
- bec pivotant 360°
- jet circulaire enrichi en air
- hauteur de robinetterie 295 mm
- hauteur jusqu'au mousseur 187 mm
- diamètre de percement 35 mm
- 2x flexible de pression M 8 x 1 vissé, étanchéité contrôlée
- débit maxi. 5,7 l/min
- sans plomb
- Ce produit contribue au respect des exigences des systèmes d'évaluation des bâtiments écologiques, par exemple LEED®, BREEAM®, DGNB

Convient uniquement à un lavabo avec trop-plein.

	Chrome	33 500 882-00
	Platine brossé	33 500 882-06
	Platine	33 500 882-08
	Dark Chrome	33 500 882-19
	Laiton brossé (Or 23cts)	33 500 882-28
	Noir mat	33 500 882-33
	Champagne brossé (Or 22cts)	33 500 882-46
	Champagne (Or 22cts)	33 500 882-47
	Chrome brossé	33 500 882-93
	Dark Platinum brossé	33 500 882-99

33 500 882
mm [inches]



Diagramme de débit



Certificats

LGA_38418.

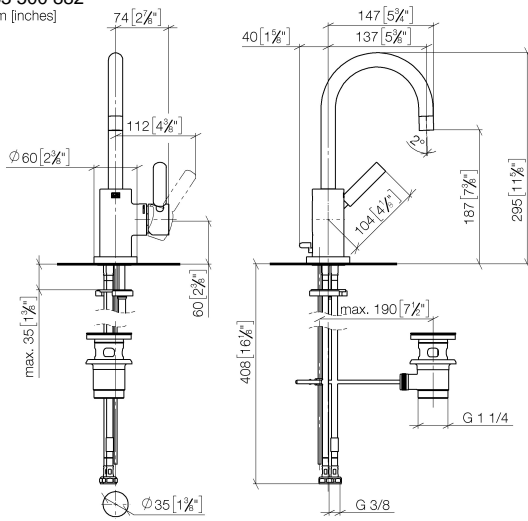
WRAS_2212025.

33 500 882

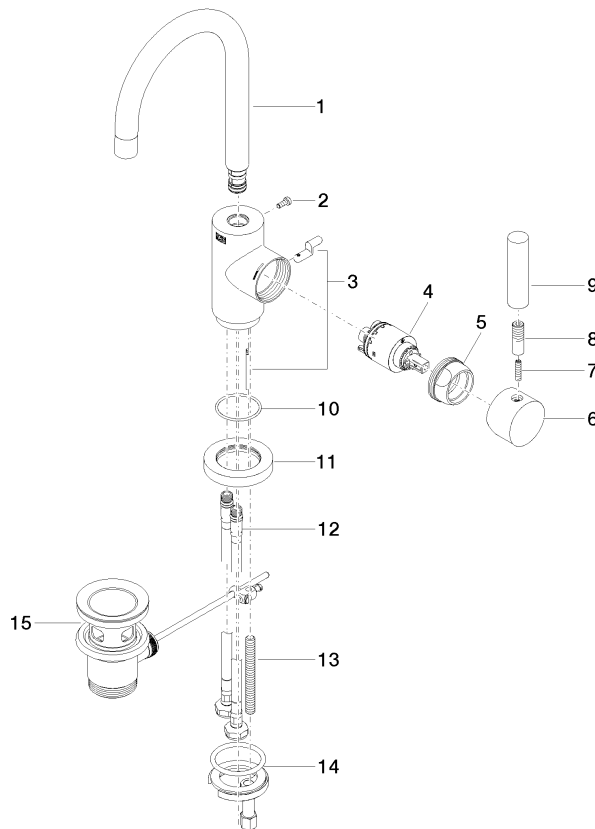

Liste des pièces de rechange

N°	Article Numéro	Désignation	Fréquence de montage	Délai de livraison
1	90 28 22 371 00-00	bec déverseur	1	10
2	09 30 30 054 90	vis	1	2
3	04 20 16 031 80-00	tige	1	10
4	90 15 05 065 00 90	cartouche	1	2
5	09 24 04 107-00	écrou	1	10
6	90 20 88 040 00-00	poignée	1	10
7	09 31 11 010 90	tige	1	2
8	90 24 04 048 00-00	raccord à vis	1	10
9	11 170 880-00	poignée	1	10
10	09 14 10 034 90	joint	1	2
11	09 28 10 055-00	rosace	1	10
12	04 30 04 104 00 90	flexible	2	2
13	09 31 11 011 90	tige	1	2
14	04 30 11 038 00 90	set de fixation	1	2
15	90 11 01 001 00-00	garniture d'écoulement	1	10