





33 805 875



- saillie 166 mm
- bec pivotant 360°
- jet laminaire
- hauteur de robinetterie 303 mm
- hauteur jusqu'au mousseur: 186 mm
- diamètre de percement 35 mm
- débit d'eau maxi. 8 l/min avec une pression d'écoulement de 3 bars
- sans plomb
- Ce produit contribue au respect des exigences des systèmes d'évaluation des bâtiments écologiques, par exemple LEED®, BREEAM®, DGNB

	Chrome	33 805 875-00
	Platine brossé	33 805 875-06
	Platine	33 805 875-08
	Laiton (Or 23cts)	33 805 875-09
	Dark Chrome	33 805 875-19
	Laiton brossé (Or 23cts)	33 805 875-28
	Noir mat	33 805 875-33
	Champagne brossé (Or 22cts)	33 805 875-46
	Champagne (Or 22cts)	33 805 875-47
	Chrome brossé	33 805 875-93
	Dark Platinum brossé	33 805 875-99

Accessoires recommandés

Commande de vidage individuelle manuelle 10 712 970-00
Commande manuelle - Chrome



Accessoires recommandés

Distributeur sans rosace - Chrome 82 424 970-00



33 805 875



Diagramme de débit



Certificats

LGA_18899.

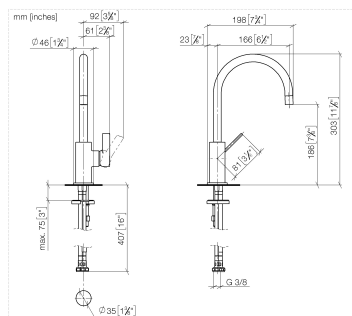
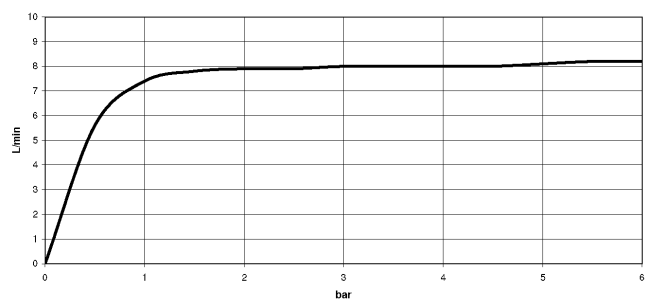
33 805 875

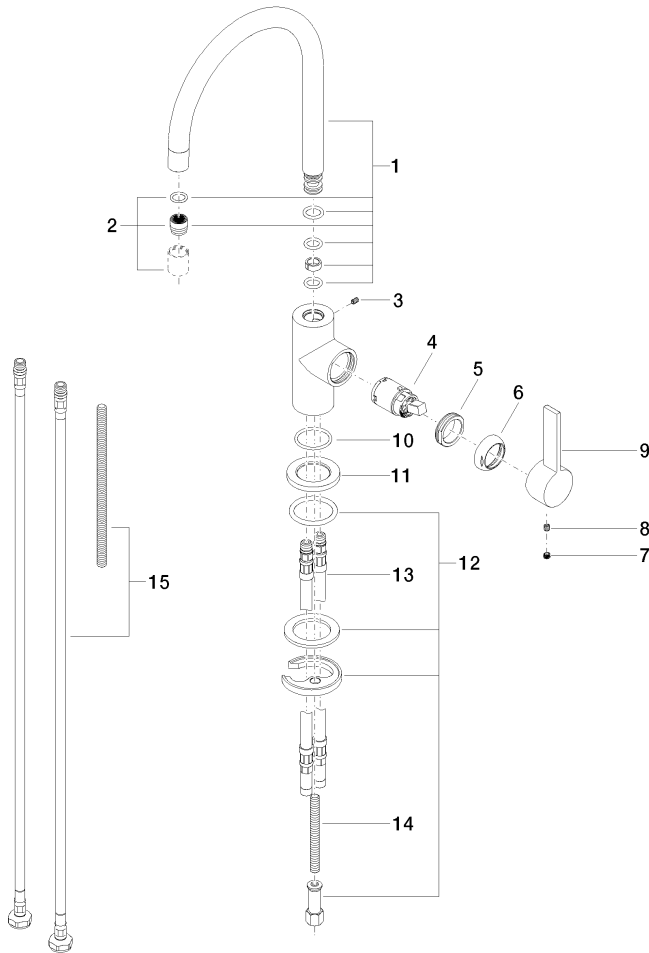

Liste des pièces de rechange

N°	Article Numéro	Désignation	Fréquence de montage	Délai de livraison
1	90 28 22 206 00-00	bec déverseur	1	10
2	90 23 01 067 00-00	mousseur	1	10
3	09 31 11 008 90	tige	1	2
4	90 15 05 041 00 90	cartouche	1	2
5	09 24 04 130-07	écrou	1	30
6	09 24 04 204-00	hotte	1	10
7	90 31 20 109 00 90	bonde de fond	1	2
8	90 31 11 030 00 90	tige	1	2
9	09 20 88 051-00	poignée	1	10
10	09 14 10 118 90	joint	1	2
11	09 27 85 001-00	rosace	1	10
12	04 30 11 038 64 90	set de fixation	1	2
13	04 30 04 016 00 90	flexible	2	60
14	09 31 11 011 90	tige	1	2
15	12 803 970 90	rallonge	1	60