

**TARA Colonne de douche avec thermostat de douche sans douchette  
FlowReduce 220 mm - Noir mat**

34 458 892 Version du produit de 5/1/2022



- saillie douche fixe 452 mm
- Pomme de douche arrosoir : PURE RAIN, débit max. 7 l/min (à 3 bar)
- Fonction à partir de: 6 l/min
- Ø de pomme de douche arrosoir 220 mm
- pomme de douche arrosoir avec système anti-calcaire
- inverseur rotatif avec régulateur de débit et fonction d'arrêt
- rosaces coulissantes Ø 70 mm
- hauteur de robinetterie jusqu'à la pomme de douche arrosoir 964 mm
- hauteur de robinetterie jusqu'au bord supérieur de l'arc 1267 mm
- calibre de percement 150 mm ± 13 mm
- flexible de douche métallique 1750 mm avec protection anti-torsion intégrée
- raccord 1/2"
- barre de douche avec curseur
- diamètre de tube 23,5 mm
- Ce produit contribue au respect des exigences des systèmes d'évaluation des bâtiments écologiques, par exemple LEED®, BREEAM®, DGNB

Cet article ne comprend pas de douchette à main !

Avec sécurité anti-retour.

	Noir mat	34 458 892-33
	Chrome	34 458 892-00
	Platine brossé	34 458 892-06
	Platine	34 458 892-08
	Dark Chrome	34 458 892-19
	Laiton brossé (Or 23cts)	34 458 892-28
	Bronze brossé	34 458 892-42
	Champagne brossé (Or 22cts)	34 458 892-46
	Champagne (Or 22cts)	34 458 892-47
	Chrome brossé	34 458 892-93
	Dark Platinum brossé	34 458 892-99

## TARA Colonne de douche avec thermostat de douche sans douchette FlowReduce 220 mm - Noir mat

34 458 892 Version du produit de 5/1/2022

### Accessoires requis

	<b>Douchette à main - Noir mat</b>	28 016 979-33
-----------------------------------------------------------------------------------	------------------------------------	---------------

### Accessoires requis

	<b>Douchette à main - Noir mat</b>	28 012 979-33
-----------------------------------------------------------------------------------	------------------------------------	---------------

### Accessoires requis

	<b>Douchette à main FlowReduce - Noir mat</b>	28 016 979-33 0010
-----------------------------------------------------------------------------------	-----------------------------------------------	-----------------------

### Accessoires requis

	<b>Douchette à main FlowReduce - Noir mat</b>	28 012 979-33 0010
-----------------------------------------------------------------------------------	-----------------------------------------------	-----------------------

### Accessoires requis

	<b>Douchette à main FlowReduce - Noir mat</b>	28 018 979-33 0010
-------------------------------------------------------------------------------------	-----------------------------------------------	-----------------------

### Accessoires requis

	<b>ARTICLES GÉNÉRIQUES Douchette à main FlowReduce - Noir mat</b>	28 029 979-33 0010
-------------------------------------------------------------------------------------	-----------------------------------------------------------------------	-----------------------

### Accessoires requis

	<b>ARTICLES GÉNÉRIQUES Douchette à main - Noir mat</b>	28 029 979-33
-------------------------------------------------------------------------------------	------------------------------------------------------------	---------------

### Accessoires requis

	<b>ARTICLES GÉNÉRIQUES Douchette à main FlowReduce - Noir mat</b>	28 025 979-33 0010
-------------------------------------------------------------------------------------	-----------------------------------------------------------------------	-----------------------

### Accessoires requis

	<b>Douchette à main - Noir mat</b>	28 016 979-33
-----------------------------------------------------------------------------------	------------------------------------	---------------

### Accessoires requis

	<b>Douchette à main FlowReduce - Noir mat</b>	28 016 979-33 0010
-----------------------------------------------------------------------------------	-----------------------------------------------	-----------------------

### Accessoires requis

	<b>Douchette à main - Noir mat</b>	28 017 979-33
-----------------------------------------------------------------------------------	------------------------------------	---------------

### Accessoires requis

	<b>Douchette à main - Noir mat</b>	28 018 979-33
-----------------------------------------------------------------------------------	------------------------------------	---------------

### Accessoires requis

	<b>ARTICLES GÉNÉRIQUES Douchette à main FlowReduce - Noir mat</b>	28 029 979-33 0010
-------------------------------------------------------------------------------------	-----------------------------------------------------------------------	-----------------------

### Accessoires requis

	<b>ARTICLES GÉNÉRIQUES Douchette à main - Noir mat</b>	28 029 979-33
-------------------------------------------------------------------------------------	------------------------------------------------------------	---------------

### Accessoires requis

	<b>ARTICLES GÉNÉRIQUES Douchette à main FlowReduce - Noir mat</b>	28 027 979-33 0010
-------------------------------------------------------------------------------------	-----------------------------------------------------------------------	-----------------------

**TARA Colonne de douche avec thermostat de douche sans douchette  
FlowReduce 220 mm - Noir mat**

34 458 892 Version du produit de 5/1/2022

mm [inches]

1:10

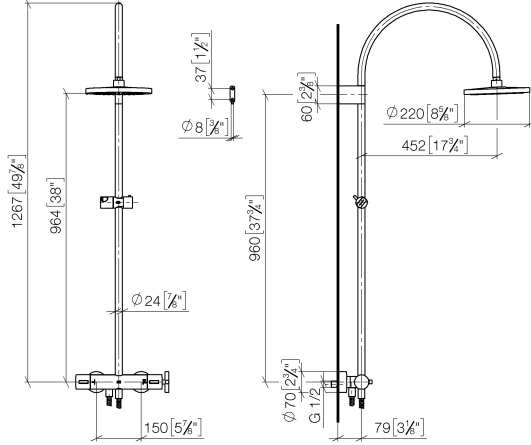

**Diagramme de débit**

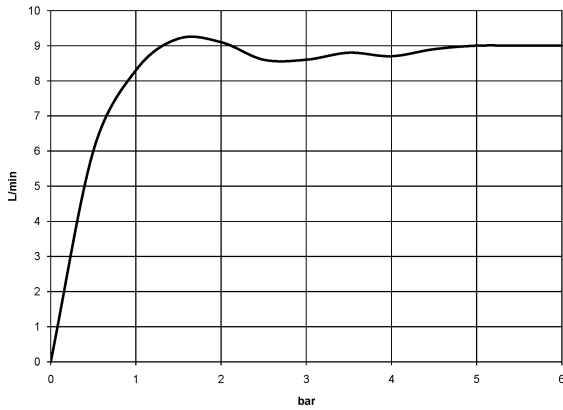

**Codes & Standards**

DIN 4109

EN 1717

ISO 3822

Scottish Water  
Byelaws

UK Water Supply  
Regulations

Ü-Zeichen



## TARA Colonne de douche avec thermostat de douche sans douchette FlowReduce 220 mm - Noir mat

---

34 458 892 Version du produit de 5/1/2022

### Certificats

---

Belgaqua\_22\_283\_2 WRAS\_2204

LGA\_38

**TARA Colonne de douche avec thermostat de douche sans douchette  
FlowReduce 220 mm - Noir mat**

34 458 892 Version du produit de 5/1/2022

Les pièces pour les  
autres finitions  
peuvent être  
trouvées ici : Chrome

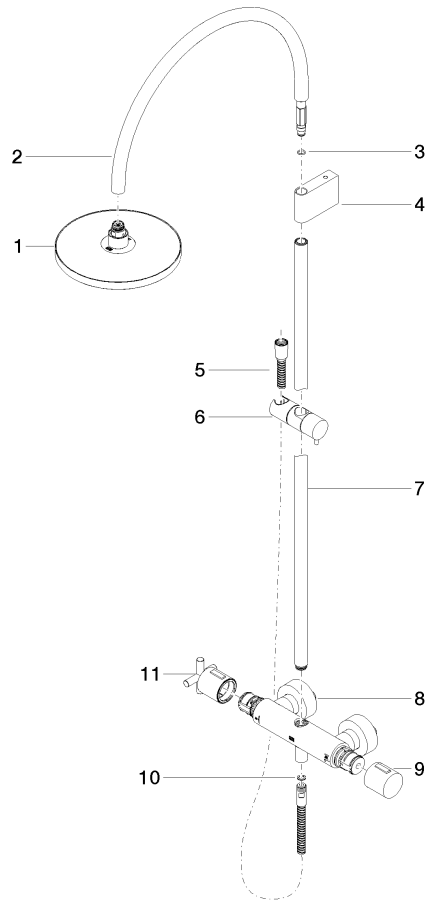

**Liste des pièces de rechange**

N°	Article Numéro	Désignation	Fréquence de montage	Délai de livraison
1	90 12 05 092 20-33	douche	1	30
2	04 28 22 346 00-33	tuyau	1	60
3	09 14 10 008 90	joint	1	2
4	90 17 11 150 00-33	patte de fixation	1	30
5	28 322 970-33	Flexible métallique de douche 1/2" x 3/8" x 1750 mm - Noir mat	1	2
6	12 570 970-33	Coulisse - Noir mat	1	30
7	90 28 22 349 00-33	tuyau	1	30
8	04 17 01 250 00-33	raccord	1	30
9	90 17 33 015 00-33	poignée	1	30
10	90 14 20 026 00 90	joint	1	2
11	90 17 33 021 00-33	poignée	1	30