







**CL.1 Robinet d'arrêt à encastrer fermant à droite froid 1/2" - Champagne
brossé (Or 22cts)**

CL.1

36 607 706



- rosace 60 x 60 mm
- avec marquage froid
- tête de commande avec broche et douille à sectionner

	Champagne brossé (Or 22cts)	36 607 706-46
	Chrome	36 607 706-00
	Platine brossé	36 607 706-06
	Dark Chrome	36 607 706-19
	Champagne (Or 22cts)	36 607 706-47
	Dark Platinum brossé	36 607 706-99

Accessoires requis



- Robinet à encastrer 1/2" -** 35 607 970 90
- profondeur de montage max. 150 mm
 - profondeur de montage mini. 105 mm



CL.1 Robinet d'arrêt à encastrer fermant à droite froid 1/2" - Champagne brossé (Or 22cts)

CL.1

36 607 706
mm [Inches]

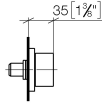

Codes & Standards

DIN 4109

ISO 3822

Scottish Water
Byelaws

UK Water Supply
Regulations

Ü-Zeichen

Certificats

WRAS_2010

LGA_29

36 607 706

Version du produit de 10/14/2020

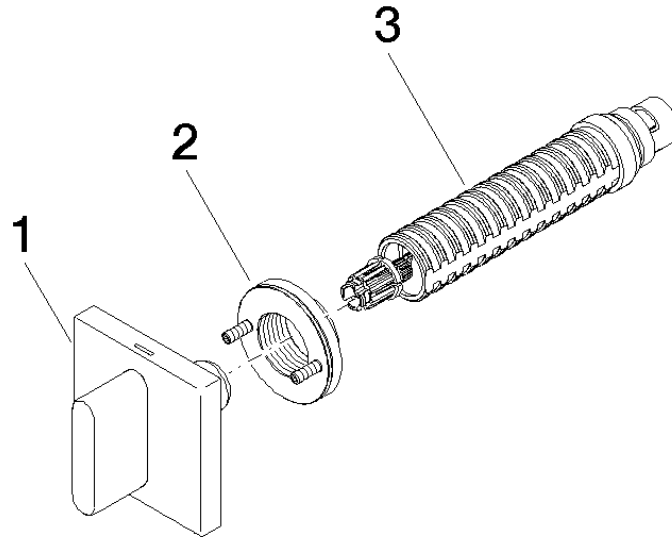



CL.1 Robinet d'arrêt à encastrer fermant à droite froid 1/2" - Champagne
brossé (Or 22cts)

CL.1

36 607 706

Liste des pièces de rechange

Version du produit de 10/14/2020

N°	Article Numéro	Désignation	Fréquence de montage	Délai de livraison
	90 20 70 051 02-46	poignée (cold)	3	30