







83 030 361



- entraxe 300 mm
- largeur 360 mm
- hauteur 60 mm
- rosace Ø 60 mm
- saillie 90 mm

	Chrome	83 030 361-00
	Platine brossé	83 030 361-06
	Platine	83 030 361-08
	Laiton (Or 23cts)	83 030 361-09
	Laiton brossé (Or 23cts)	83 030 361-28
	Dark Platinum brossé	83 030 361-99

Accessoires recommandés



MADISON Fixation pour inverseur 12 358 970 90
pour montage biface sur verre -
 •pour la fixation d'un porte-serviette,
 porte-serviette arrière en sus.

83 030 361

mm [inches]



83 030 361

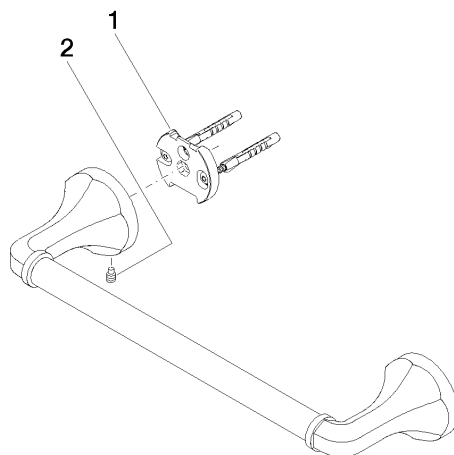

Liste des pièces de rechange

N°	Article Numéro	Désignation	Fréquence de montage	Délai de livraison
1	05 17 97 507 00 90	set de fixation	2	2
2	04 31 11 140 00 90	tige	2	2