







ST 050 200 1360



- barre de douche avec curseur
- diamètre de tube 18 mm
- rosace Ø 60 mm
- entraxe 850 mm
- flexible de douche métallique 1750 mm avec protection anti-torsion intégrée
- raccord de flexible de douche 1/2"
- COMPACT RAIN, débit max. 9 l/min (à 3 bar)
- pomme de douche Ø 64 mm
- Ce produit contribue au respect des exigences des systèmes d'évaluation des bâtiments écologiques, par exemple LEED®, BREEAM®, DGNB

	Laiton (Or 23cts)	ST 050 200 1360-09
	Chrome	ST 050 200 1360-00
	Platine brossé	ST 050 200 1360-06
	Platine	ST 050 200 1360-08
	Laiton brossé (Or 23cts)	ST 050 200 1360-28
	Dark Platinum brossé	ST 050 200 1360-99

Composants individuels de ce set

Ce set requiert les composants suivants



1x 28 002 970-09



1x 26 413 360-09



MADISON Garniture de douche - Laiton (Or 23cts)

MADISON















ST 050 200 1360

ST 050 200 1360



- COMPACT RAIN, débit max. 9 l/min (à 3 bar)
- Fonction à partir de: 6 l/min
- pomme de douche Ø 64 mm
- raccord 1/2"

Avec sécurité anti-retour.

	Laiton (Or 23cts)	28 002 970-09
	Chrome	28 002 970-00
	Chrome	28 002 970-00 0010
	Or (23,9cts)	28 002 970-01
	Platine brossé	28 002 970-06
	Platine brossé	28 002 970-06 0010
	Platine	28 002 970-08
	Platine	28 002 970-08 0010
	Laiton (Or 23cts)	28 002 970-09 0010
	Laiton brossé (Or 23cts)	28 002 970-28
	Laiton brossé (Or 23cts)	28 002 970-28 0010
	Chrome brossé	28 002 970-93
	Chrome brossé	28 002 970-93 0010
	Dark Platinum brossé	28 002 970-99
	Dark Platinum brossé	28 002 970-99 0010

ST 050 200 1360

mm [inches]



Diagramme de débit

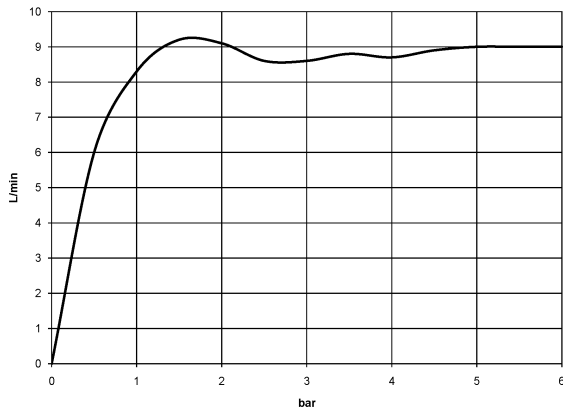

Certificats

LGA_8492.

WRAS_240502026.

ST 050 200 1360

Les pièces pour les autres finitions peuvent être trouvées ici : [Chrome](#)



Liste des pièces de rechange







N°	Article Numéro	Désignation	Fréquence de montage	Délai de livraison
1	90 12 01 010 00 90	set	1	2
2	09 14 10 069 90	joint	1	2
3	09 24 04 059 20-09	raccord à vis	1	40
4	09 14 10 042 90	joint	1	2
5	90 28 22 033 00-09	élément insérable	1	-
La pièce de rechange ne peut plus être commandée, veuillez commander l'article de remplacement				
6	11 167 820 60	poignée	1	2
7	09 23 01 077 90	limiteur de débit	1	2
8	09 23 01 039 90	tamis	1	2

ST 050 200 1360



- barre de douche avec curseur
- diamètre de tube 18 mm
- rosace Ø 60 mm
- entraxe 850 mm
- flexible de douche métallique 1750 mm avec protection anti-torsion intégrée
- raccord de flexible de douche 1/2"

Cet article ne comprend pas de douchette à main !

	Laiton (Or 23cts)	26 413 360-09
	Chrome	26 413 360-00
	Platine brossé	26 413 360-06
	Platine	26 413 360-08
	Laiton brossé (Or 23cts)	26 413 360-28
	Dark Platinum brossé	26 413 360-99

Accessoires recommandés

	Coude mural à encastrer - ●profondeur de montage max. 163 mm ●profondeur de montage mini. 90 mm	35 085 970 90
---	--	---------------

Accessoires recommandés

	MADISON Coude mural - Laiton (Or 23cts)	28 450 410-09
---	--	---------------

Accessoires requis

	MADISON Douchette à main FlowReduce - Laiton (Or 23cts) ●pomme de douche Ø 95 mm ●Douchette à main voir page {PAGE} ●3 jets réglables : COMPACT RAIN, COMPACT SOFT FLOW, COMPACT AQUAPRESSURE FLOW, débit max. l/min (à 3 bar)	28 002 978-09 0010
---	--	-----------------------

Accessoires requis

	MADISON Douchette à main - Laiton (Or 23cts) ●pomme de douche Ø 95 mm ●Douchette à main voir page {PAGE} ●3 jets réglables : COMPACT RAIN, COMPACT SOFT FLOW, COMPACT AQUAPRESSURE FLOW, débit max. l/min (à 3 bar)	28 002 978-09
---	---	---------------

Accessoires requis

	MADISON Douchette à main en laiton avec poignée en porcelaine (blanche) FlowReduce - Laiton (Or 23cts)	28 002 970-09 0010
---	---	-----------------------

ST 050 200 1360

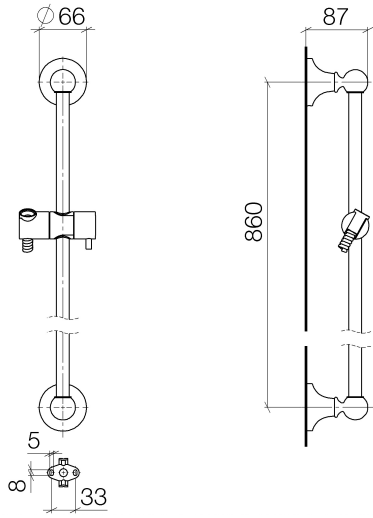

Certificats

WRAS_2009048. IAPMO_4976 (2).

ST 050 200 1360

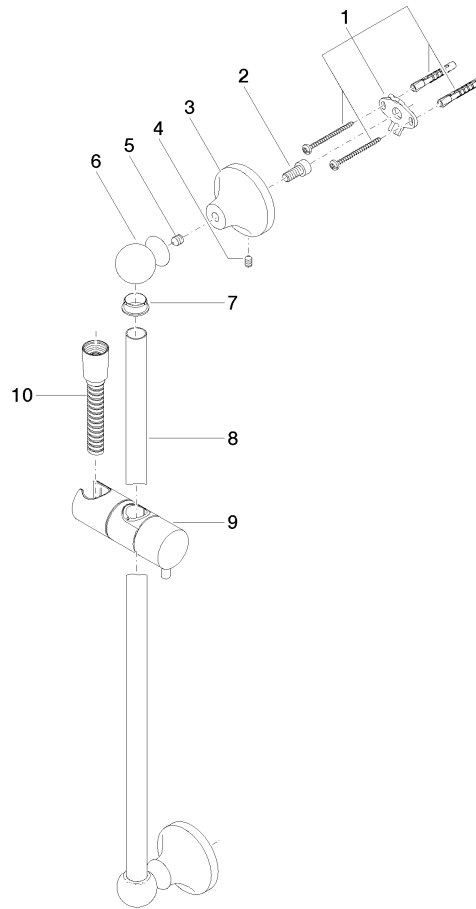

Liste des pièces de rechange

N°	Article Numéro	Désignation	Fréquence de montage	Délai de livraison
1	90 17 20 708 00 90	set de fixation	2	2
2	09 30 30 048 90	vis	2	2
3	09 17 20 016-09	patte de fixation	2	40
4	09 31 11 144 90	tige	2	2
5	09 31 11 002 90	tige	2	2
6	09 21 40 020-09	raccord	2	60
7	09 18 40 009 90	douille	2	2
8	08 28 22 596-09	tuyau	1	60
9	12 580 970-09	curseur	1	40
10	28 204 970-09	Flexible métallique de douche 1/2" x 1/2" x 1750 mm - Laiton (Or 23cts)	1	40