







ST 050 200 1360



- barre de douche avec curseur
- diamètre de tube 18 mm
- rosace Ø 60 mm
- entraxe 850 mm
- flexible de douche métallique 1750 mm avec protection anti-torsion intégrée
- raccord de flexible de douche 1/2"
- COMPACT RAIN, débit max. 9 l/min (à 3 bar)
- pomme de douche Ø 64 mm
- Ce produit contribue au respect des exigences des systèmes d'évaluation des bâtiments écologiques, par exemple LEED®, BREEM®, DGNB

| | | |
|--|--------------------------|--------------------|
|  | Laiton brossé (Or 23cts) | ST 050 200 1360-28 |
|  | Chrome | ST 050 200 1360-00 |
|  | Platine brossé | ST 050 200 1360-06 |
|  | Platine | ST 050 200 1360-08 |
|  | Laiton (Or 23cts) | ST 050 200 1360-09 |
|  | Dark Platinum brossé | ST 050 200 1360-99 |

Composants individuels de ce set

Ce set requiert les composants suivants



1x 28 002 970-28



1x 26 413 360-28

















ST 050 200 1360



- COMPACT RAIN, débit max. 9 l/min (à 3 bar)
- Fonction à partir de: 6 l/min
- pomme de douche Ø 64 mm
- raccord 1/2"

Avec sécurité anti-retour.

| | | |
|--|--------------------------|--------------------|
|  | Laiton brossé (Or 23cts) | 28 002 970-28 |
|  | Chrome | 28 002 970-00 |
|  | Chrome | 28 002 970-00 0010 |
|  | Or (23,9cts) | 28 002 970-01 |
|  | Platine brossé | 28 002 970-06 |
|  | Platine brossé | 28 002 970-06 0010 |
|  | Platine | 28 002 970-08 |
|  | Platine | 28 002 970-08 0010 |
|  | Laiton (Or 23cts) | 28 002 970-09 |
|  | Laiton (Or 23cts) | 28 002 970-09 0010 |
|  | Laiton brossé (Or 23cts) | 28 002 970-28 0010 |
|  | Chrome brossé | 28 002 970-93 |
|  | Chrome brossé | 28 002 970-93 0010 |
|  | Dark Platinum brossé | 28 002 970-99 |
|  | Dark Platinum brossé | 28 002 970-99 0010 |

ST 050 200 1360

mm [inches]



Diagramme de débit

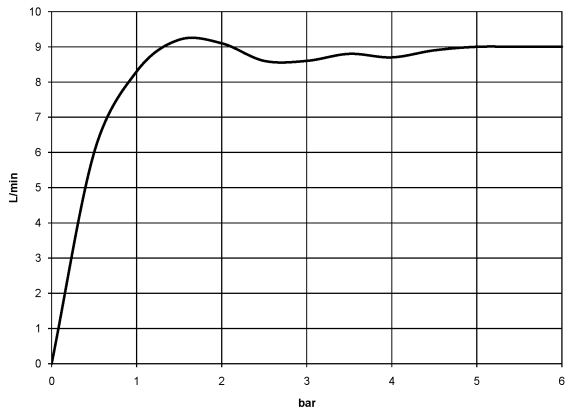

Certificats

LGA_8492.

WRAS_240502026.

ST 050 200 1360

Les pièces pour les autres finitions peuvent être trouvées ici : [Chrome](#)



Liste des pièces de rechange

| N° | Article Numéro | Désignation | Fréquence de montage | Délai de livraison |
|----|--------------------|---------------------|----------------------|--------------------|
| 1 | 90 12 01 010 00 90 | set | 1 | 2 |
| 2 | 09 14 10 069 90 | joint | 1 | 2 |
| 3 | 09 24 04 059 20-28 | raccord à vis | 1 | 20 |
| 4 | 09 14 10 042 90 | joint | 1 | 2 |
| 5 | 90 28 22 033 00-28 | élément insérable | 1 | 20 |
| 6 | 11 167 820 60 | poignée | 1 | 2 |
| 7 | 09 23 01 077 90 | limitateur de débit | 1 | 2 |
| 8 | 09 23 01 039 90 | tamis | 1 | 2 |

ST 050 200 1360



- barre de douche avec curseur
- diamètre de tube 18 mm
- rosace Ø 60 mm
- entraxe 850 mm
- flexible de douche métallique 1750 mm avec protection anti-torsion intégrée
- raccord de flexible de douche 1/2"

Cet article ne comprend pas de douchette à main !

| | | |
|--|--------------------------|---------------|
| | Laiton brossé (Or 23cts) | 26 413 360-28 |
| | Chrome | 26 413 360-00 |
| | Platine brossé | 26 413 360-06 |
| | Platine | 26 413 360-08 |
| | Laiton (Or 23cts) | 26 413 360-09 |
| | Dark Platinum brossé | 26 413 360-99 |

Accessoires recommandés

| | | |
|--|--|---------------|
| | Coude mural à encastrer - ●profondeur de montage max. 163 mm ●profondeur de montage mini. 90 mm | 35 085 970 90 |
|--|--|---------------|

Accessoires requis

| | | |
|--|--|--------------------|
| | MADISON Douchette à main en laiton avec poignée en porcelaine (blanche) FlowReduce - Laiton brossé (Or 23cts) | 28 002 970-28 0010 |
|--|--|--------------------|

Accessoires requis

| | | |
|--|---|--------------------|
| | MADISON Douchette à main FlowReduce - Laiton brossé (Or 23cts) ●pomme de douche Ø 95 mm ●Douchette à main voir page {PAGE} ●3 jets réglables : COMPACT RAIN, COMPACT SOFT FLOW, COMPACT AQUAPRESSURE FLOW, débit max. l/min (à 3 bar) | 28 002 978-28 0010 |
|--|---|--------------------|

Accessoires recommandés

| | | |
|--|---|---------------|
| | MADISON Coude mural - Laiton brossé (Or 23cts) | 28 450 410-28 |
|--|---|---------------|

Accessoires requis

| | | |
|--|--|---------------|
| | MADISON Douchette à main - Laiton brossé (Or 23cts) ●pomme de douche Ø 95 mm ●Douchette à main voir page {PAGE} ●3 jets réglables : COMPACT RAIN, COMPACT SOFT FLOW, COMPACT AQUAPRESSURE FLOW, débit max. l/min (à 3 bar) | 28 002 978-28 |
|--|--|---------------|

ST 050 200 1360

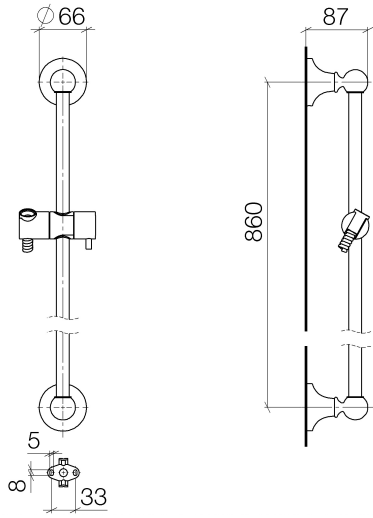

Certificats

WRAS_2009048.

ST 050 200 1360

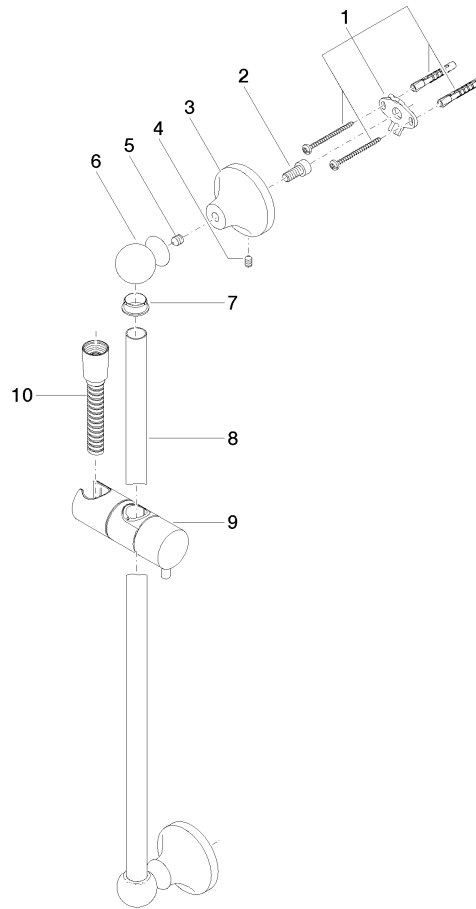

Liste des pièces de rechange

| N° | Article Numéro | Désignation | Fréquence de montage | Délai de livraison |
|----|--------------------|--|----------------------|--------------------|
| 1 | 90 17 20 708 00 90 | set de fixation | 2 | 2 |
| 2 | 09 30 30 048 90 | vis | 2 | 2 |
| 3 | 09 17 20 016-28 | patte de fixation | 2 | 60 |
| 4 | 09 31 11 144 90 | tige | 2 | 2 |
| 5 | 09 31 11 002 90 | tige | 2 | 2 |
| 6 | 09 21 40 020-28 | raccord | 2 | 20 |
| 7 | 09 18 40 009 90 | douille | 2 | 2 |
| 8 | 08 28 22 596-28 | tuyau | 1 | 20 |
| 9 | 12 580 970-28 | Coulisse - Laiton brossé (Or 23cts) | 1 | 20 |
| 10 | 28 204 970-28 | Flexible métallique de douche 1/2" x 1/2" x 1750 mm - Laiton brossé (Or 23cts) | 1 | 2 |