

ST 050 203 9979



S'adapte aux gammes suivantes : IMO, LULU, MEM, TARA, CL.1, LISSÉ, VAIA, META, CYO

- barre de douche avec curseur
- diamètre de tube 18 mm
- entraxe 853 mm
- flexible de douche métallique 1750 mm avec protection anti-torsion intégrée
- raccord de flexible de douche 3/8"
- 3 ou 5 jets réglables : COMPACT RAIN, COMPACT SOFT FLOW, COMPACT AQUAPRESSURE FLOW, débit max. 15 l/min (à 3 bar)
- Fonction à partir de: 7 l/min
- pomme de douche Ø 100 mm

	Chrome	ST 050 203 9979-00
	Chrome	ST 050 203 2979-00 0010
	Platine brossé	ST 050 203 9979-06
	Platine brossé	ST 050 203 2979-06 0010
	Platine	ST 050 203 9979-08
	Platine	ST 050 203 2979-08 0010
	Dark Chrome	ST 050 203 9979-19
	Dark Chrome	ST 050 203 2979-19 0010
	Or clair	ST 050 203 2979-26 0010
	Or clair	ST 050 203 9979-26
	Or clair brossé	ST 050 203 9979-27
	Or clair brossé	ST 050 203 2979-27 0010
	Laiton brossé (Or 23cts)	ST 050 203 9979-28
	Laiton brossé (Or 23cts)	ST 050 203 2979-28 0010
	Noir mat	ST 050 203 9979-33
	Noir mat	ST 050 203 2979-33 0010
	Bronze brossé	ST 050 203 2979-42 0010
	Bronze brossé	ST 050 203 9979-42
	Champagne brossé (Or 22cts)	ST 050 203 9979-46
	Champagne brossé (Or 22cts)	ST 050 203 2979-46 0010
	Champagne (Or 22cts)	ST 050 203 9979-47
	Champagne (Or 22cts)	ST 050 203 2979-47 0010
	Chrome brossé	ST 050 203 9979-93
	Chrome brossé	ST 050 203 2979-93 0010
	Dark Platinum brossé	ST 050 203 9979-99
	Dark Platinum brossé	ST 050 203 2979-99 0010

ST 050 203 9979

Composants individuels de ce set

Ce set requiert les composants suivants



1x 26 413 979-00



1x 28 018 979-00



Garniture de douche - Chrome

IMO

ST 050 203 9979

ST 050 203 9979



S'adapte aux gammes suivantes : IMO, LULU, MEM, TARA, CL.1, LISSÉ, VAIA, META, CYO

- barre de douche avec curseur
- diamètre de tube 18 mm
- entraxe 853 mm
- flexible de douche métallique 1750 mm avec protection anti-torsion intégrée
- raccord de flexible de douche 3/8"

Cet article ne comprend pas de douchette à main !

	Chrome	26 413 979-00
	Platine brossé	26 413 979-06
	Platine	26 413 979-08
	Dark Chrome	26 413 979-19
	Or clair	26 413 979-26
	Or clair brossé	26 413 979-27
	Laiton brossé (Or 23cts)	26 413 979-28
	Noir mat	26 413 979-33
	Bronze brossé	26 413 979-42
	Champagne brossé (Or 22cts)	26 413 979-46
	Champagne (Or 22cts)	26 413 979-47
	Chrome brossé	26 413 979-93
	Dark Platinum brossé	26 413 979-99

ST 050 203 9979

Accessoires recommandés

	Coude mural à encastrer - ●profondeur de montage max. 163 mm ●profondeur de montage mini. 90 mm	35 085 970 90
---	--	---------------

Accessoires recommandés

	LISSÉ Coude mural - Chrome	28 450 845-00
---	-----------------------------------	---------------

Accessoires requis

	Douchette à main FlowReduce - Chrome ●Débit max. 6,8 l/min (à 3 bar)	28 016 979-00 0010
---	--	-----------------------

Accessoires requis

	Douchette à main FlowReduce - Chrome ●Débit max. 6,8 l/min (à 3 bar)	28 012 979-00 0010
---	--	-----------------------

Accessoires requis

	Douchette à main - Chrome ●Débit max. 15 l/min (à 3 bar)	28 012 979-00
---	--	---------------

Accessoires requis

	Douchette à main FlowReduce - Chrome ●Débit max. 6,8 l/min (à 3 bar)	28 018 979-00 0010
---	--	-----------------------

Accessoires recommandés

	Coude mural - Chrome	28 450 980-00
---	-----------------------------	---------------

Accessoires requis

	Douchette à main - Chrome ●Débit max. 15 l/min (à 3 bar)	28 015 979-00
---	--	---------------

Accessoires requis

	Douchette à main - Chrome ●Débit max. 15 l/min (à 3 bar)	28 017 979-00
---	--	---------------

Accessoires requis

	Douchette à main - Chrome ●Débit max. 15 l/min (à 3 bar)	28 016 979-00
---	--	---------------

Accessoires requis

	Douchette à main - Chrome ●Débit max. 15 l/min (à 3 bar)	28 018 979-00
---	--	---------------



Garniture de douche - Chrome

IMO

ST 050 203 9979

ST 050 203 9979

mm [inches]

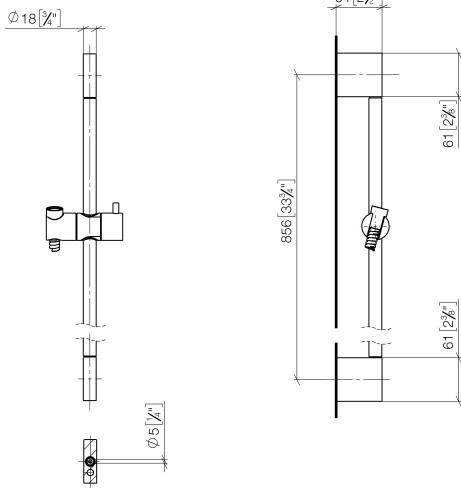

Certificats

WRAS_2009048. ACS_20 ACC LY 738. IAPMO_4976 (1).

ST 050 203 9979

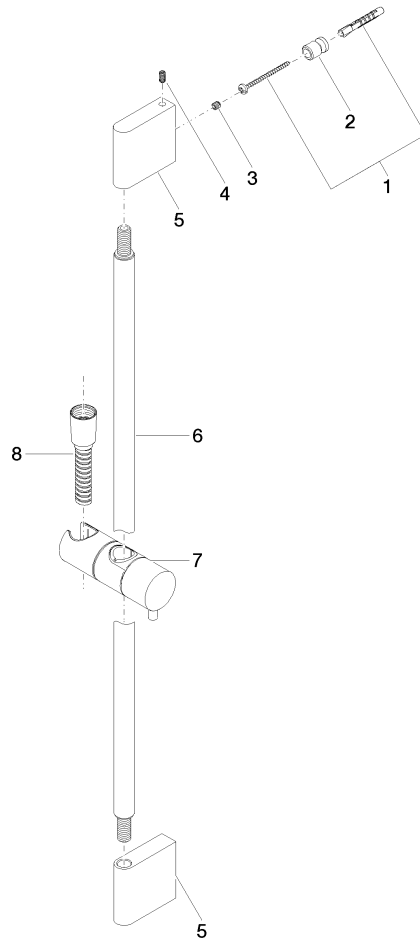

Liste des pièces de rechange

N°	Article Numéro	Désignation	Fréquence de montage	Délai de livraison
1	05 17 20 726 02 90	set de fixation	2	2
2	08 17 20 726 90	patte de fixation	2	2
3	09 31 11 049 90	tige	2	2
4	04 31 11 113 00 90	tige	2	2
5	08 17 97 054-00	patte de fixation	2	10
6	90 28 22 597 00-00	patte de fixation	1	10
7	12 580 970-00	Coulisse - Chrome	1	10
8	28 322 970-00	Flexible métallique de douche 1/2" x 3/8" x 1750 mm - Chrome	1	2

ST 050 203 9979



- 3 ou 5 jets réglables : COMPACT RAIN, COMPACT SOFT FLOW, COMPACT AQUAPRESSURE FLOW, débit max. 15 l/min (à 3 bar)
- avec système anti-calcaire
- pomme de douche Ø 100 mm
- raccord 1/2"
- Fonction à partir de: 7 l/min

Avec sécurité anti-retour.

S'adapte aux gammes suivantes : IMO, LULU, MADISON, MEM, TARA, CL.1, LISSÉ, VAIA, META, CYO

	Chrome	28 018 979-00
	Chrome	28 018 979-00 0010
	Platine brossé	28 018 979-06
	Platine brossé	28 018 979-06 0010
	Platine	28 018 979-08
	Platine	28 018 979-08 0010
	Dark Brass matt	28 018 979-16 0010
	Dark Bronze matt	28 018 979-17 0010
	Dark Chrome	28 018 979-19
	Dark Chrome	28 018 979-19 0010
	Or clair	28 018 979-26 0010
	Or clair	28 018 979-26
	Or clair brossé	28 018 979-27 0010
	Or clair brossé	28 018 979-27
	Laiton brossé (Or 23cts)	28 018 979-28
	Laiton brossé (Or 23cts)	28 018 979-28 0010
	Noir mat	28 018 979-33
	Noir mat	28 018 979-33 0010
	Bronze brossé	28 018 979-42 0010
	Bronze brossé	28 018 979-42
	Champagne brossé (Or 22cts)	28 018 979-46
	Champagne brossé (Or 22cts)	28 018 979-46 0010
	Champagne (Or 22cts)	28 018 979-47
	Champagne (Or 22cts)	28 018 979-47 0010
	Chrome brossé	28 018 979-93
	Chrome brossé	28 018 979-93 0010
	Dark Platinum brossé	28 018 979-99
	Dark Platinum brossé	28 018 979-99 0010



Garniture de douche - Chrome

IMO

ST 050 203 9979

ST 050 203 9979

mm [inches]



Diagramme de débit



Certificats

LGA_29984.

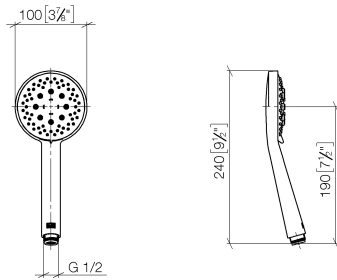
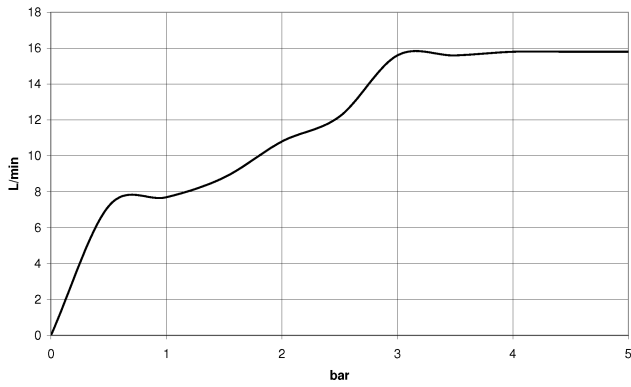
DVGW_DW-
6517DN0129.

WRAS_2210003.

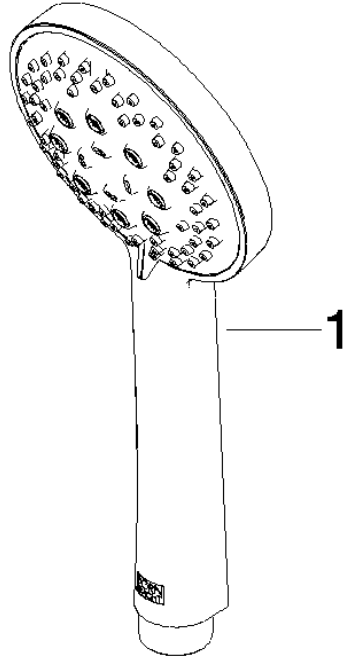

Liste des pièces de rechange

N°	Article Numéro	Désignation	Fréquence de montage	Délai de livraison
1	09 23 01 039 90	tamis	1	2