







ST 050 304 6360



- saillie douche fixe 420 mm
- Pomme de douche arrosoir : PURE RAIN, débit max. 14 l/min (à 3 bar)
- Fonction à partir de: 8 l/min
- Ø de pomme de douche arrosoir 200 mm
- pomme de douche arrosoir avec système anti-calcaire
- Douchette à main : 3 ou 5 jets réglables : COMPACT RAIN, COMPACT SOFT FLOW, COMPACT AQUAPRESSURE FLOW, débit max. 9 l/min (à 3 bar)
- pomme de douche Ø 95 mm
- inverseur rotatif barre de douche/douchette à main
- hauteur de robinetterie jusqu'à la pomme de douche arrosoir 985 mm
- hauteur de robinetterie jusqu'au bord supérieur de l'arc 1160 mm
- rosaces coulissantes en deux parties Ø 65 mm
- rosace pour support de douche Ø 65 mm
- rosace pour fixation murale Ø 60 mm
- calibre de percement 150 mm ± 13 mm
- flexible de douche métallique 1250 mm avec protection anti-torsion intégrée
- raccord 1/2"
- diamètre de tube 20 mm

	Chrome	ST 050 304 6360-00
	Platine brossé	ST 050 304 6360-06
	Platine	ST 050 304 6360-08
	Laiton (Or 23cts)	ST 050 304 6360-09
	Laiton brossé (Or 23cts)	ST 050 304 6360-28
	Dark Platinum brossé	ST 050 304 6360-99

Composants individuels de ce set

Ce set requiert les composants suivants



1x 11 420 360-00









1x 28 002 978-00



1x 34 459 360-00

ST 050 304 6360



	Chrome	11 420 360-00
	Platine brossé	11 420 360-06
	Platine	11 420 360-08
	Laiton (Or 23cts)	11 420 360-09
	Laiton brossé (Or 23cts)	11 420 360-28
	Dark Platinum brossé	11 420 360-99

ST 050 304 6360



ST 050 304 6360

Les pièces pour les autres finitions peuvent être trouvées ici : Platine brossé

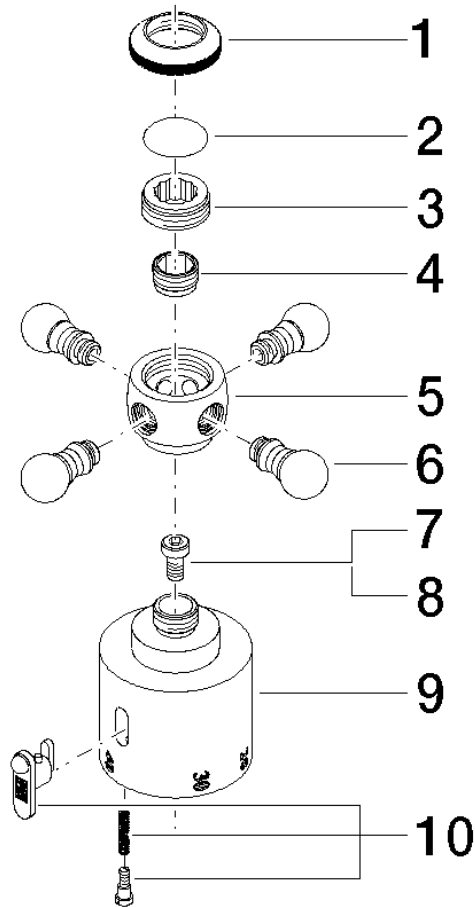

Liste des pièces de rechange

N°	Article Numéro	Désignation	Fréquence de montage	Délai de livraison
1	09 20 36 005-00	poignée	1	10
2	09 26 01 016 90	accessoires	1	2
3	09 20 83 006 90	poignée	1	2
4	09 24 03 119 90	raccord à vis	1	2
6	09 20 36 004-00	poignée	4	10
7	90 30 30 027 00 90	vis	1	2
8	09 30 33 004 90	vis	1	2
10	90 21 33 020 00 90	poignée	1	2

ST 050 304 6360



- 3 jets réglables : COMPACT RAIN, COMPACT SOFT FLOW, COMPACT AQUAPRESSURE FLOW, débit max. 9 l/min (à 3 bar)
- avec système anti-calcaire
- pomme de douche Ø 95 mm
- raccord 1/2"

Avec sécurité anti-retour.

	Chrome	28 002 978-00
	Chrome	28 002 978-00 0010
	Platine brossé	28 002 978-06
	Platine brossé	28 002 978-06 0010
	Platine	28 002 978-08
	Platine	28 002 978-08 0010
	Laiton (Or 23cts)	28 002 978-09
	Laiton (Or 23cts)	28 002 978-09 0010
	Laiton brossé (Or 23cts)	28 002 978-28
	Laiton brossé (Or 23cts)	28 002 978-28 0010
	Chrome brossé	28 002 978-93
	Chrome brossé	28 002 978-93 0010
	Dark Platinum brossé	28 002 978-99
	Dark Platinum brossé	28 002 978-99 0010

ST 050 304 6360

mm [inches]



Diagramme de débit



Certificats

LGA_18610.

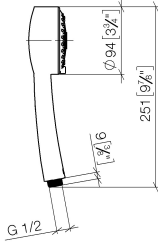
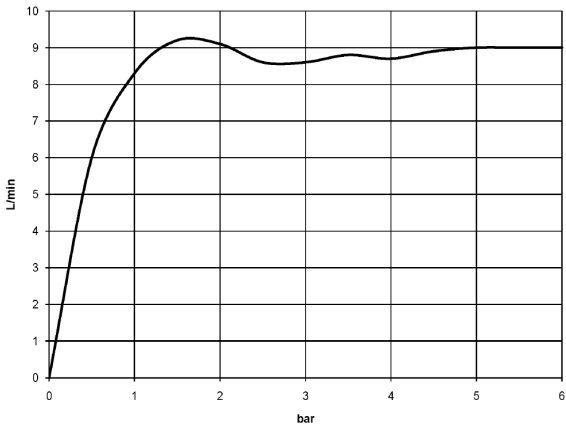
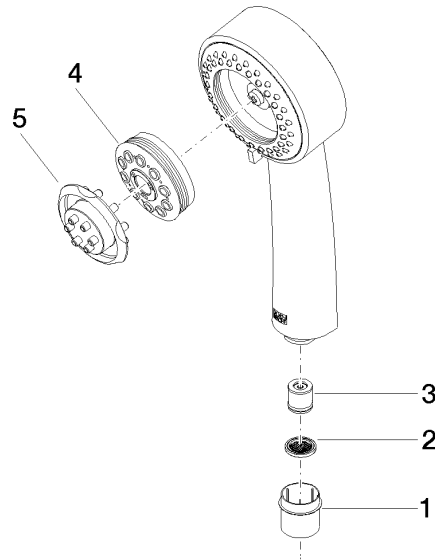

Liste des pièces de rechange

N°	Article Numéro	Désignation	Fréquence de montage	Délai de livraison
1	09 21 02 115 90	capuchon	1	2
2	09 23 01 039 90	tamis	1	2
3	09 23 01 077 90	limitateur de débit	1	2
4	04 12 11 071 00 90	douche	1	2
5	09 30 09 022 90	clé à écrou	1	2

ST 050 304 6360









- saillie douche fixe 420 mm
- Ø de pomme de douche arrosoir 200 mm
- pomme de douche arrosoir avec système anti-calcaire
- débit maxi. de la pomme de douche arrosoir 14 l/min
- Fonction à partir de: 8 l/min
- inverseur rotatif barre de douche/douchette à main
- hauteur de robinetterie jusqu'à la pomme de douche arrosoir 985 mm
- hauteur de robinetterie jusqu'au bord supérieur de l'arc 1160 mm
- rosaces coulissantes en deux parties Ø 65 mm
- rosace pour support de douche Ø 65 mm
- rosace pour fixation murale Ø 60 mm
- calibre de percement 150 mm ± 13 mm
- flexible de douche métallique 1250 mm avec protection anti-torsion intégrée
- raccord 1/2"
- diamètre de tube 20 mm

Cet article ne comprend pas de douchette à main !

Avec sécurité anti-retour.

ATTENTION :Les poignées doivent être commandées indépendamment des robinetteries!

	Chrome	34 459 360-00
	Platine brossé	34 459 360-06
	Platine	34 459 360-08
	Laiton (Or 23cts)	34 459 360-09
	Laiton brossé (Or 23cts)	34 459 360-28
	Dark Platinum brossé	34 459 360-99

ST 050 304 6360



Diagramme de débit



Certificats

LGA_38665.

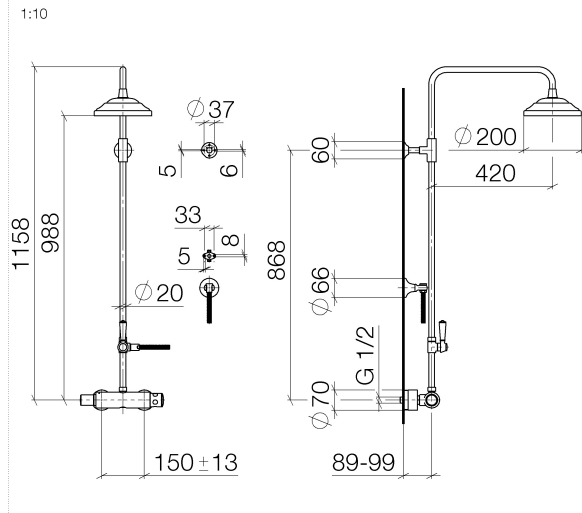
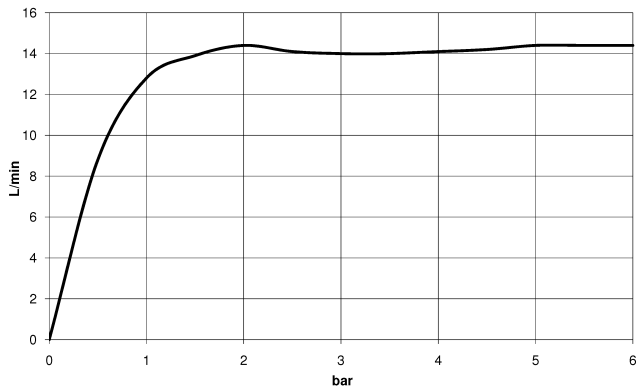
ST 050 304 6360

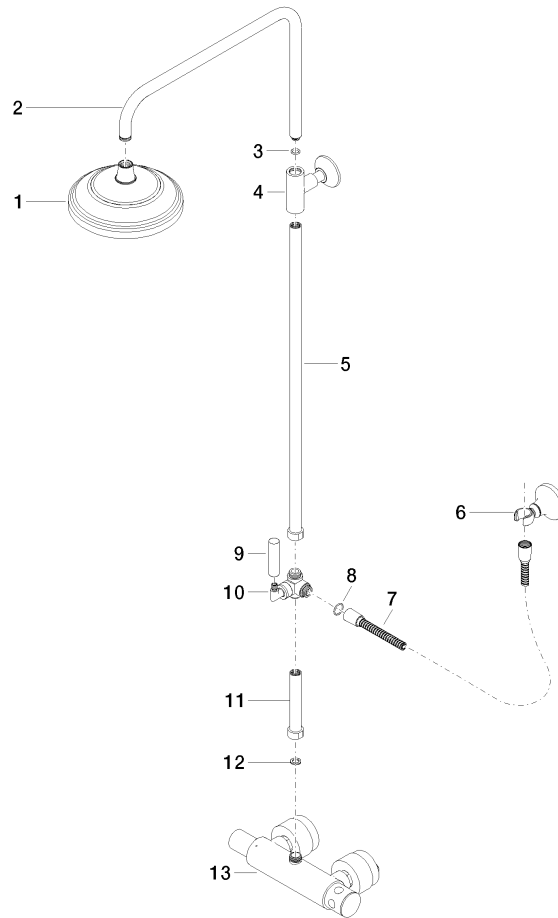

Liste des pièces de rechange

N°	Article Numéro	Désignation	Fréquence de montage	Délai de livraison
1	04 12 05 038 01-00	douche	1	60
2	04 28 22 101 20-00	bec déverseur	1	10
3	90 14 10 011 00 90	joint	1	2
4	90 17 11 037 01-00	patte de fixation	1	10
5	90 28 22 104 00-00	tuyau	1	10
6	28 050 410-00	patte de fixation	1	60
7	28 104 970-00	Flexible métallique de douche 1/2" x 1/2" x 1250 mm - Chrome	1	2
8	09 14 10 122 90	joint	1	2
9	11 170 370-00	MADISON Grand insert à poignée - Chrome	1	10
10	90 17 09 045 01-00	inverseur	1	10
11	90 28 22 103 00-00	tuyau	1	10
12	90 14 20 002 00 90	joint	1	2
13	04 17 01 044 01-00	robinetterie	1	10