













13 415 979



- 150mm projection
- CASCADE, max. flow rate 26.5 l/min (at 3 bar)
- cover plate 240 x 60 mm
- 1/2" connection
- plug-link mounting
- WRAS 2306001

Fits: IMO, LULU, MADISON, MEM, TARA,
CL.1, LISSÉ, VAIA, META, CYO

| | | |
|---|-------------------------------------|---------------|
|  | Brushed Platinum | 13 415 979-06 |
|  | Chrome | 13 415 979-00 |
|  | Platinum | 13 415 979-08 |
|  | Dark Chrome | 13 415 979-19 |
|  | Light Gold | 13 415 979-26 |
|  | Brushed Light Gold | 13 415 979-27 |
|  | Brushed Durabronze (23kt Gold) | 13 415 979-28 |
|  | Matte Black | 13 415 979-33 |
|  | Brushed Bronze | 13 415 979-42 |
|  | Brushed Champagne (22kt Gold) | 13 415 979-46 |
|  | Champagne (22kt Gold) | 13 415 979-47 |
|  | Brushed Chrome | 13 415 979-93 |
|  | Brushed Dark Platinum | 13 415 979-99 |

13 415 979

mm [inches]

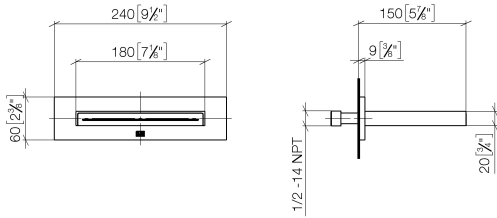

Flow rate chart

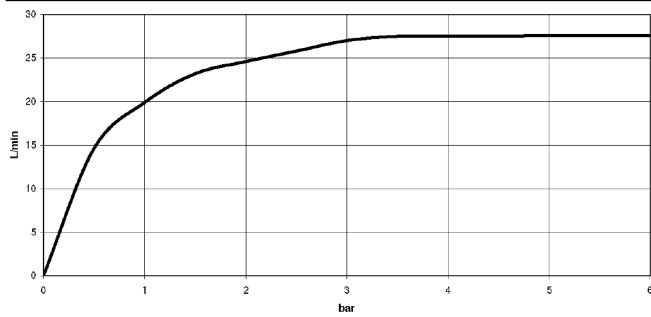

Trajectory diagram

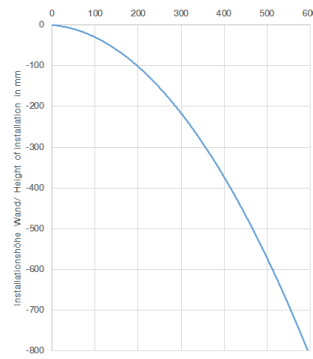

Codes & Standards

- ASME
- A112.18.1/CSA
- B125.1



WATER SHEET Cascade spout for wall mounting - Brushed Platinum

IMO

13 415 979

Certificates

LGA_19464.

WRAS_2306001.

IAPMO_4976 (6).

13 415 979

Parts for other finishes can be found here: [Chrome](#)

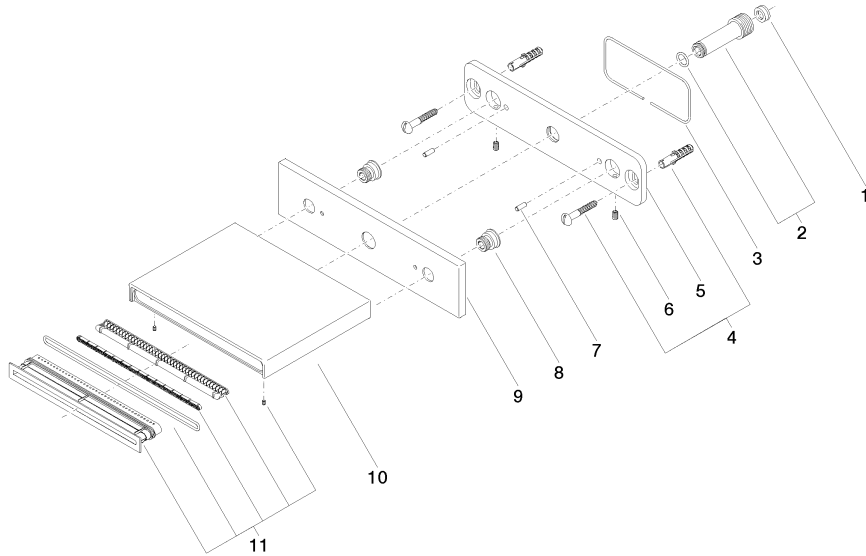

Spare parts list

| No. | Item Number | Name | Quantity used | Delivery time |
|-----|--------------------|--------------|---------------|---------------|
| 1 | 09 23 01 057 90 | flow reducer | 1 | 2 |
| 2 | 90 24 03 213 00 90 | connection | 1 | 2 |
| 3 | 09 14 03 134 90 | seal | 1 | 2 |
| 4 | 04 30 31 024 01 90 | fixing set | 1 | 2 |
| 5 | 09 17 97 059 90 | holder | 1 | 2 |
| 6 | 09 31 11 036 90 | pin | 2 | 2 |
| 7 | 09 31 11 040 90 | pin | 2 | 2 |
| 8 | 09 24 03 214 90 | nipple | 2 | 2 |
| 10 | 09 11 78 003 20-06 | spout | 1 | 10 |
| 11 | 90 29 03 059 00 90 | insert | 1 | 2 |