









13 672 661



- 282mm projection
- circular normal flow
- total height 811 - 881 mm
- height up to aerator 671 – 741 mm
- slide-on rosettes Ø 135 mm
- max. flow 28.6 l/min at 3 bar flow pressure
- WRAS 2001026

	Dark Chrome	13 672 661-19
	Chrome	13 672 661-00
	Brushed Platinum	13 672 661-06
	Light Gold	13 672 661-26
	Brushed Light Gold	13 672 661-27
	Matte Black	13 672 661-33
	Brushed Bronze	13 672 661-42
	Brushed Chrome	13 672 661-93
	Brushed Dark Platinum	13 672 661-99

13 672 661

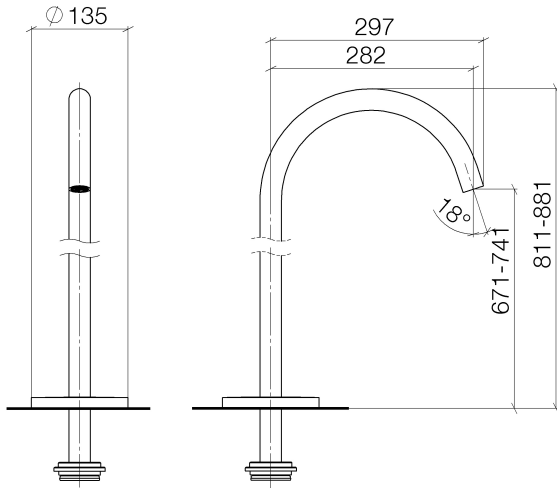

Flow rate chart

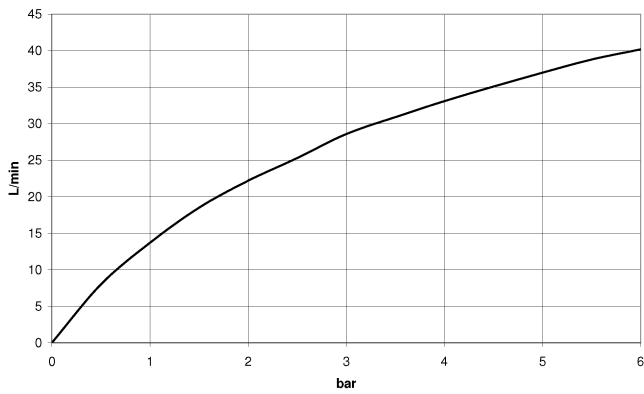

Codes & Standards

ASME
A112.18.1/CSA
B125.1

13 672 661

Parts for other
finishes can be found
here: [Chrome](#)

