











19 870 809



- 240mm projection
- pivotable spout 360°
- Optional swivel limiter available with swivel limiter set 12 823 970 90
- air-enriched flow and spray flow
- height of mixer 393 mm
- height up to laminar flow regulator 204 mm
- hole diameter 35 mm
- 2 x pressure hose with 3/8" cap nut
- 1800 mm metal shower hose
- sprayface with anti-scaling system
- max. flow 5.7 l/min at 3 bar flow pressure
- lead-free
- This product can help a building meet the requirements of Green Building Rating Systems, e.g. LEED®, BREEAM®, DGNB

Intrinsic protection against back flow.

Switch back and forth between aerator and spray mode while water is running.

|   |                                |                    |
|---|--------------------------------|--------------------|
|    | Chrome                         | 19 870 809-00 0010 |
|    | Brushed Platinum               | 19 870 809-06 0010 |
|    | Platinum                       | 19 870 809-08 0010 |
|    | Durabronze (23kt Gold)         | 19 870 809-09 0010 |
|    | Dark Chrome                    | 19 870 809-19 0010 |
|    | Brushed Durabronze (23kt Gold) | 19 870 809-28 0010 |
|    | Matte Black                    | 19 870 809-33 0010 |
|    | Brushed Champagne (22kt Gold)  | 19 870 809-46 0010 |
|    | Champagne (22kt Gold)          | 19 870 809-47 0010 |
|   | Brushed Chrome                 | 19 870 809-93 0010 |
|  | Brushed Dark Platinum          | 19 870 809-99 0010 |

Recommended miscellaneous

Swivel limitation set -

12 823 970 90



Recommended miscellaneous

VAIA Dispenser with rosette -  
Chrome

82 434 809-00



Recommended miscellaneous

VAIA AIR SWITCH Control button - 10 713 809-00  
Chrome



19 870 809

mm [inches]  
1:5

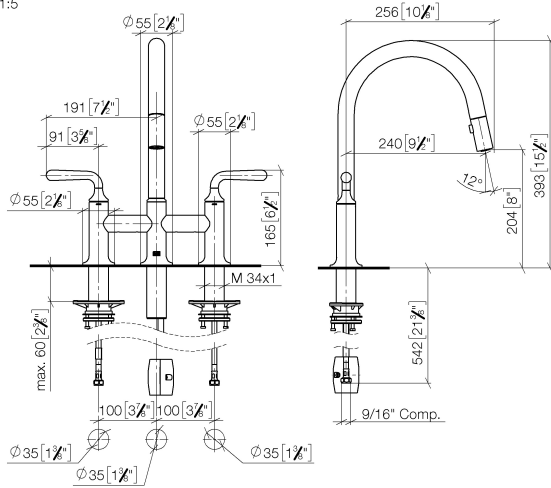

**Flow rate chart**

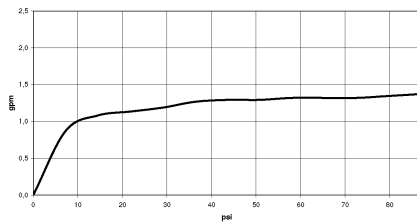

**Codes & Standards**

California Energy  
Commission  
(CEC)

19 870 809

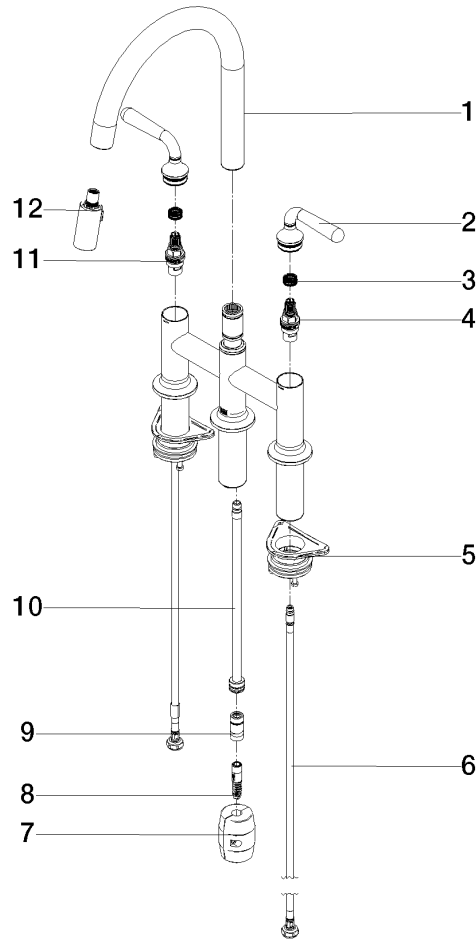

### Spare parts list

| No. | Item Number        | Name        | Quantity used | Delivery time |
|-----|--------------------|-------------|---------------|---------------|
| 1   | 90 28 22 397 00-00 | spout       | 1             | 10            |
| 2   | 90 20 80 057 00-00 | handle      | 2             | 10            |
| 3   | 90 12 12 232 00 90 | fixing cap  | 2             | 2             |
| 4   | 90 90 03 130 00 90 | top         | 1             | 2             |
| 5   | 04 30 11 040 00 90 | fixing set  | 2             | 2             |
| 6   | 04 30 04 103 00 90 | hose        | 2             | 2             |
| 7   | 04 21 50 010 00 90 | accessories | 1             | 2             |
| 8   | 04 30 02 120 00-00 | hose        | 1             | 10            |
| 9   | 90 24 03 253 00 90 | adaptor     | 1             | 2             |
| 10  | 04 28 20 067 00 90 | pipe        | 1             | 2             |
| 11  | 90 90 03 131 00 90 | top         | 1             | 2             |
| 12  | 90 18 40 317 00-00 | shower      | 1             | 10            |