







20 700 360 Product version from 7/31/2009



- 135mm projection
- 1 1/4" pop-up waste
- fixed spout
- circular, air-enriched flow
- height of mixer 72 mm
- height up to aerator 40 mm
- hole diameter valve 32 mm
- hole diameter spout 35 mm
- without rosette
- 2x 1/2" x 1/2" high pressure hose
- max. flow 4.5 l/min
- lead-free
- This product can help a building meet the requirements of Green Building Rating Systems, e.g. LEED®, BREEAM®, DGNB

Only suitable for basins with an overflow.

	Brushed Platinum	20 700 360-06 0010
	Chrome	20 700 360-00 0010
	Platinum	20 700 360-08 0010
	Durabass (23kt Gold)	20 700 360-09 0010
	Brushed Durabass (23kt Gold)	20 700 360-28 0010
	Brushed Dark Platinum	20 700 360-99 0010

20 700 360 Product version from 7/31/2009

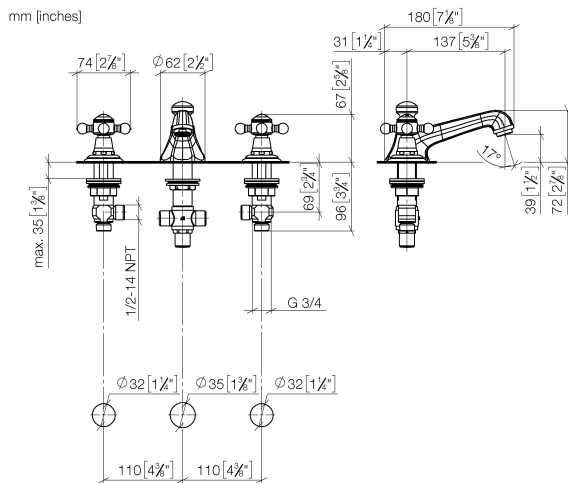

**Codes & Standards**

ADA	ASME A112.18.1/CSA B125.1	California Energy Commission (CEC)	NSF/ANSI 372
NSF/ANSI/CAN 61	NSF372	NSF61	

**Certificates**

IAPMO\_N-4      IAPMO\_6

20 700 360 Product version from 7/31/2009

Parts for other finishes can be found here: [Chrome](#)

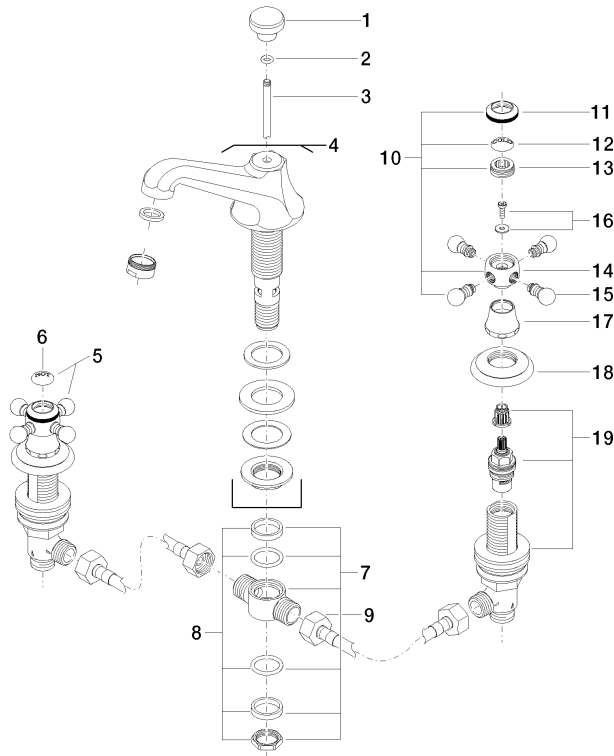

20 ————— Ablaufgarnitur 04.11.01.001.00.FP

**Spare parts list**

No.	Item Number	Name	Quantity used	Delivery time
1	09 20 36 030-06	handle	1	10
2	90 14 10 062 00 90	seal	1	2
3	09 31 09 004-06	pull-rod	1	10
4	13 700 380-06 0010	spout	1	-
Spare part can no longer be ordered, please order the replacement item				
5	04 20 36 002 07-06	handle ( hot )	1	10
6	09 26 01 011 90	accessories	1	2
7	90 17 11 020 10 90	distributor	1	2
8	90 23 10 012 00 90	gasket kit	1	2
9	04 30 04 096 00 90	hose	2	2
10	04 20 36 002 06-06	handle ( cold )	1	10
11	09 20 36 005-06	handle	2	10
12	09 26 01 010 90	accessories	1	2
13	09 20 83 006 90	handle	2	2
14	09 20 36 002-06	handle	2	10
15	09 20 36 004-06	handle	8	10
16	04 30 30 029 00 90	fixing set	2	2
17	09 21 02 055-06	cover	2	10
18	09 27 35 001-06	rosette	2	10
19	90 17 11 040 51 90	side panel	2	2
20	90 11 01 023 00-06	pop-up waste	1	10