







20 705 782



- 165mm projection
- fixed spout
- rectangular, air-enriched flow
- height of mixer 144 mm
- height up to aerator 78 mm
- hole diameter spout 35 mm
- hole diameter valve 32 mm
- rosette 60 x 60 mm
- 2x screw-in M 10 x 1 pressure hose, leak-tested
- max. flow 4.5 l/min
- lead-free
- This product can help a building meet the requirements of Green Building Rating Systems, e.g. LEED®, BREEAM®, DGNB

Only suitable for basins with an overflow.

	Brushed Dark Platinum	20 705 782-99 0010
	Chrome	20 705 782-00 0010
	Brushed Platinum	20 705 782-06 0010
	Platinum	20 705 782-08 0010
	Dark Chrome	20 705 782-19 0010
	Brushed Durabronze (23kt Gold)	20 705 782-28 0010

20 705 782

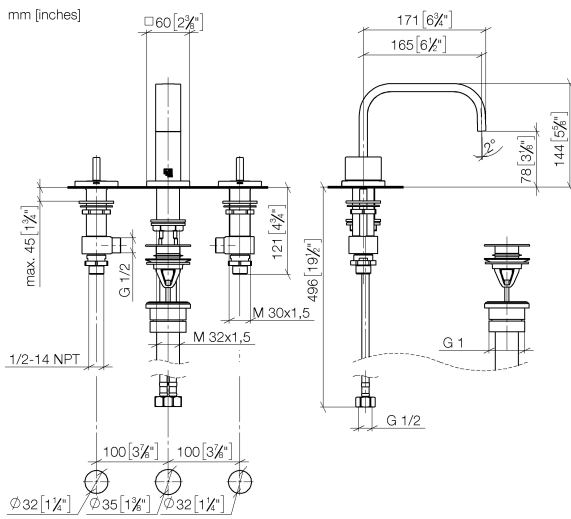

Flow rate chart



Codes & Standards

California Energy
Commission
(CEC)

20 705 782

Parts for other finishes can be found here: [Chrome](#)

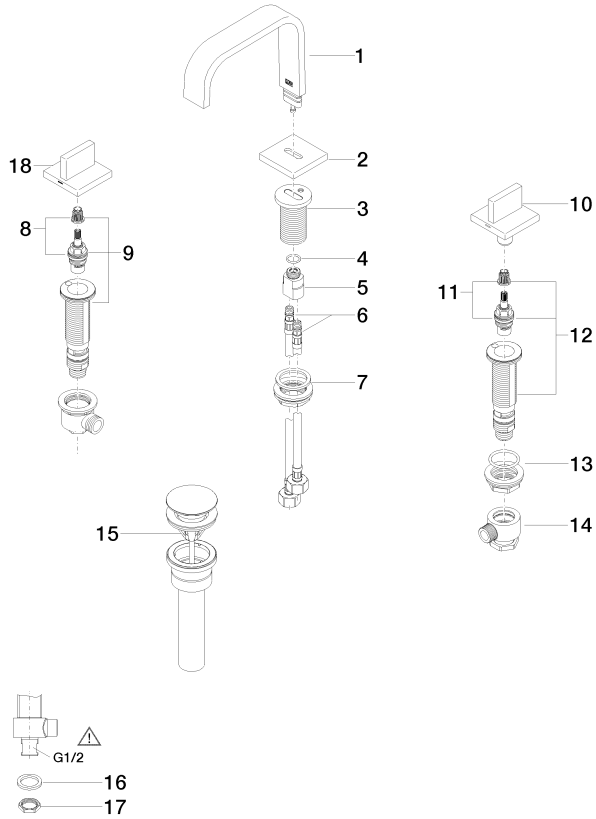

Spare parts list

No.	Item Number	Name	Quantity used	Delivery time
1	90 28 22 360 00-99	spout	1	30
2	09 27 78 034-99	rosette	1	30
3	09 11 10 054 10 90	connection	1	2
4	09 14 10 130 90	seal	1	2
5	09 11 10 055 10 90	connection	1	2
6	04 30 04 019 00 90	hose	2	2
7	04 23 10 009 01 90	fixing set	1	2
8	90 90 03 152 00 90	top	1	2
9	04 17 11 058 52 90	side panel	1	2
10	90 20 78 002 04-99	handle (cold)	1	30
11	90 90 03 153 00 90	top	1	2
12	04 17 11 058 53 90	side panel	1	2
13	04 23 10 032 78 90	fixing set	2	2
14	04 17 11 023 10 90	distributor	2	2
15	10 125 970-99 0010	Basin Waste 1 1/4" - Brushed Dark Platinum	1	30
16	09 30 11 059 90	disc	2	2
17	09 23 10 012 90	nut	2	2
18	90 20 78 002 05-99	handle (hot)	1	30