

**TARA Three-hole basin mixer with pop-up waste - Brushed Durabross (23kt Gold)**











TARA

20 705 882



- 166mm projection
- 1 1/4" pop-up waste
- pivotable spout 360°
- circular, air-enriched flow
- height of mixer 145 mm
- height up to aerator 65 mm
- hole diameter valve 32 mm
- hole diameter spout 35 mm
- rosette Ø 55 mm
- 2x screw-in M 10 x 1 pressure hose, leak-tested
- max. flow 4.5 l/min
- lead-free
- This product can help a building meet the requirements of Green Building Rating Systems, e.g. LEED®, BREEAM®, DGNB

Only suitable for basins with an overflow.

	Brushed Durabross (23kt Gold)	20 705 882-28 0010
	Chrome	20 705 882-00 0010
	Brushed Platinum	20 705 882-06 0010
	Platinum	20 705 882-08 0010
	Dark Chrome	20 705 882-19 0010
	Matte Black	20 705 882-33 0010
	Brushed Champagne (22kt Gold)	20 705 882-46 0010
	Champagne (22kt Gold)	20 705 882-47 0010
	Brushed Chrome	20 705 882-93 0010
	Brushed Dark Platinum	20 705 882-99 0010

20 705 882  
mm [inches]

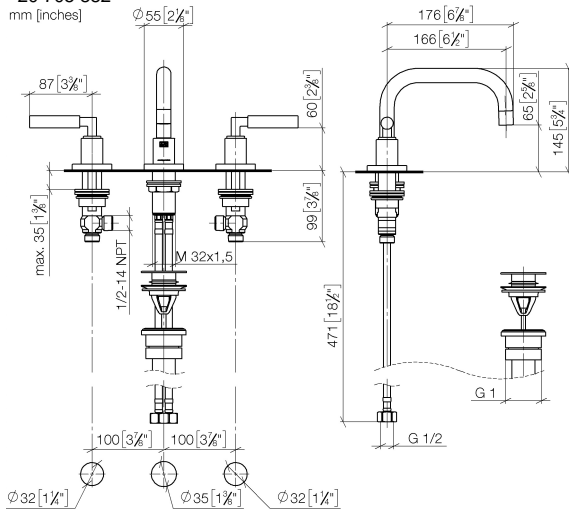

**Flow rate chart**

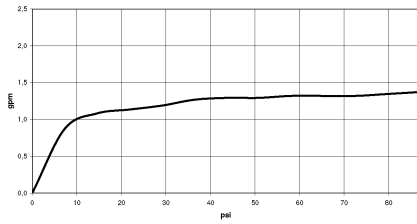

**Codes & Standards**

California Energy  
Commission  
(CEC)



TARA Three-hole basin mixer with pop-up waste - Brushed Durabronz (23kt Gold)

---

TARA

20 705 882

Certificates

---

IAPMO\_N-4976.

IAPMO\_6397.

20 705 882  
Parts for other finishes can be found here: [Chrome](#)

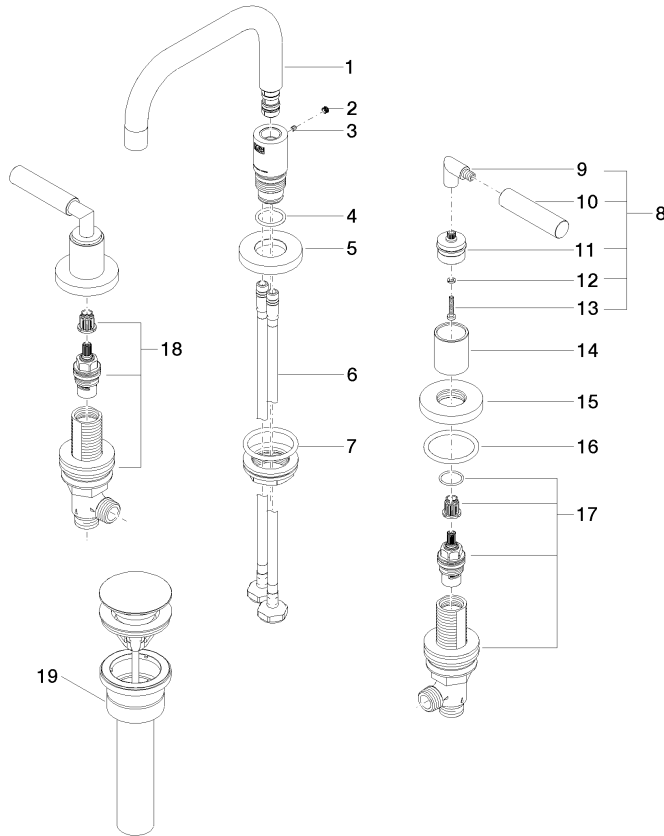

**Spare parts list**

No.	Item Number	Name	Quantity used	Delivery time
1	90 28 22 370 01-28	spout	1	20
2	90 31 20 109 00 90	plug	1	2
3	09 31 11 099 90	pin	1	2
4	09 14 10 015 90	seal	1	2
5	09 28 10 140-28	ring	1	20
6	04 30 04 019 00 90	hose	2	2
7	04 23 10 009 02 90	fixing set	1	2
8	04 20 88 052 10-28	handle	2	20
9	04 18 20 022 00-28	angle	2	-
Spare part can no longer be ordered, please order the replacement item				
10	09 20 88 052-28	handle	2	20
11	90 12 12 219 00-28	base	2	20
12	90 30 11 029 00 90	disc	2	2
13	90 30 30 075 00 90	screw	2	2
14	09 21 02 140-28	sleeve	2	20
15	09 27 89 105-28	rosette	2	20
16	90 14 10 043 00 90	seal	2	2
17	90 17 11 040 50 90	side panel	1	2
18	90 17 11 040 51 90	side panel	1	2
19	10 125 970-28 0010	Basin Waste 1 1/4" - Brushed Durabross (23kt Gold)	1	2