





20 713 809



- 168mm projection
- 1 1/4" pop-up waste
- pivotable spout 360°
- circular, air-enriched flow
- height of mixer 280 mm
- height up to aerator 191 mm
- hole diameter valve 32 mm
- hole diameter spout 35 mm
- rosette Ø 60 mm
- max. flow 4.5 l/min
- lead-free
- This product can help a building meet the requirements of Green Building Rating Systems, e.g. LEED®, BREEAM®, DGNB

Only suitable for basins with an overflow.

	Dark Chrome	20 713 809-19 0010
	Chrome	20 713 809-00 0010
	Brushed Platinum	20 713 809-06 0010
	Platinum	20 713 809-08 0010
	Brushed Durabronze (23kt Gold)	20 713 809-28 0010
	Brushed Bronze	20 713 809-42 0010
	Brushed Champagne (22kt Gold)	20 713 809-46 0010
	Champagne (22kt Gold)	20 713 809-47 0010
	Brushed Dark Platinum	20 713 809-99 0010

20 713 809

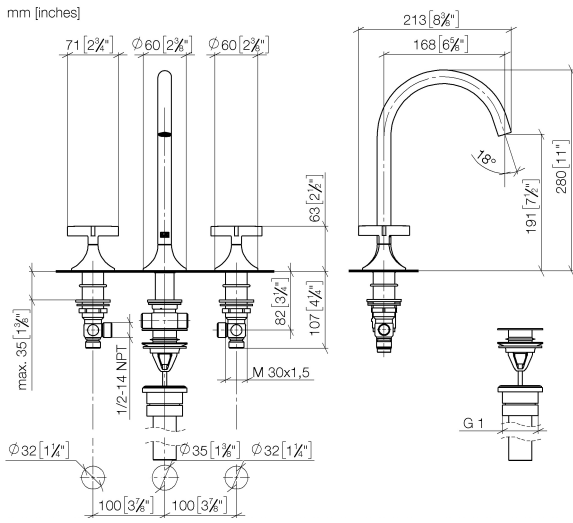

**Flow rate chart**

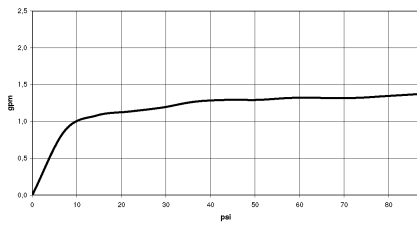

**Codes & Standards**

ADA

ASME  
A112.18.1/CSA  
B125.1

California Energy  
Commission  
(CEC)

NSF/ANSI 372

NSF/ANSI/CAN  
61



## VAIA Three-hole basin mixer with pop-up waste - Dark Chrome

---

VAIA

20 713 809

### Certificates

---

IAPMO\_N-4976.    IAPMO\_6397.

20 713 809

Parts for other  
finishes can be found  
here: [Chrome](#)

