







**IMO Single-hole basin mixer with stand pipe without pop-up waste - Brushed Chrome**

IMO

22 585 671



- 195mm projection
- fixed spout
- rectangular, air-enriched flow
- total height 1038 - 1103 mm
- height up to aerator 970 – 1040 mm
- rosette Ø 135 mm
- max. flow 4.6 l/min
- lead-free
- This product can help a building meet the requirements of Green Building Rating Systems, e.g. LEED®, BREEAM®, DGNB

	Brushed Chrome	22 585 671-93 0010
	Chrome	22 585 671-00 0010
	Brushed Platinum	22 585 671-06 0010
	Dark Chrome	22 585 671-19 0010
	Matte Black	22 585 671-33 0010
	Brushed Dark Platinum	22 585 671-99 0010

**Required miscellaneous**



- Concealed floor mounting -** 35 949 970-90  
 •min. recess depth 80 mm 0010  
 •max. recess depth 150 mm

**IMO Single-hole basin mixer with stand pipe without pop-up waste - Brushed Chrome**

IMO

22 585 671  
mm [inches]

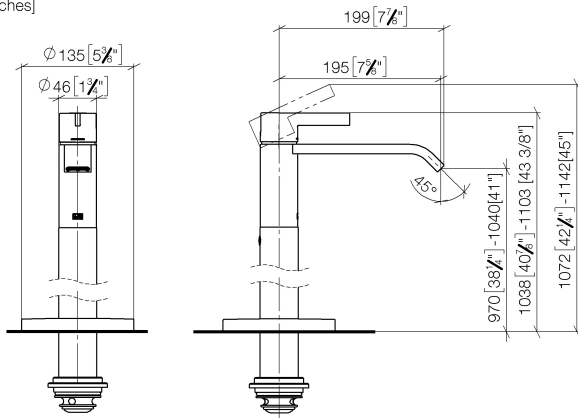

**Flow rate chart**

