











VAIA Single-hole basin mixer with stand pipe without pop-up waste - Dark Chrome

VAIA

22 585 809



- 202mm projection
- pivotable spout 360°
- circular, air-enriched flow
- total height 1251 - 1321 mm
- height up to aerator 1152 – 1222 mm
- rosette Ø 135 mm
- max. flow 4.5 l/min
- lead-free
- This product can help a building meet the requirements of Green Building Rating Systems, e.g. LEED®, BREEAM®, DGNB

	Dark Chrome	22 585 809-19 0010
	Chrome	22 585 809-00 0010
	Brushed Platinum	22 585 809-06 0010
	Platinum	22 585 809-08 0010
	Brushed Durabronze (23kt Gold)	22 585 809-28 0010
	Brushed Bronze	22 585 809-42
	Brushed Bronze	22 585 809-42 0010
	Brushed Champagne (22kt Gold)	22 585 809-46 0010
	Champagne (22kt Gold)	22 585 809-47 0010
	Brushed Dark Platinum	22 585 809-99 0010

Required miscellaneous



- Concealed floor mounting -**
- max. recess depth 150 mm
 - min. recess depth 80 mm

35 949 970-90
0010



VAIA Single-hole basin mixer with stand pipe without pop-up waste - Dark Chrome

VAIA

22 585 809
mm [inches]

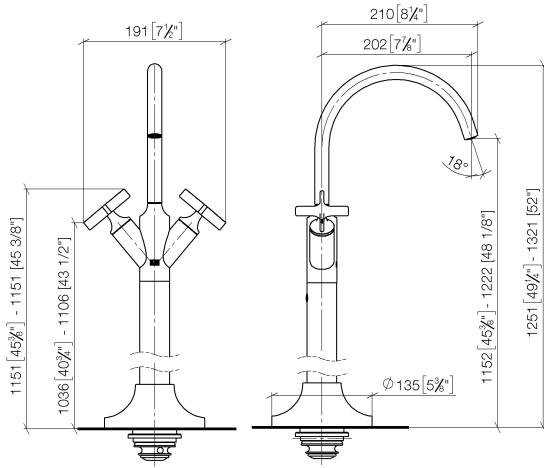

Flow rate chart

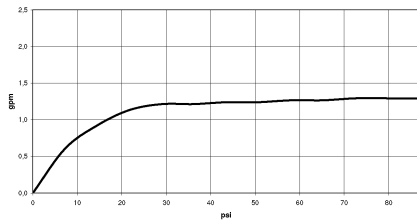

Codes & Standards

California Energy
Commission
(CEC)

22 585 809



Spare parts list

No.	Item Number	Name	Quantity used	Delivery time
1	90 28 22 313 01-19	spout	1	20
2	90 20 66 028 00-19	handle (cold)	1	20
3	90 20 66 029 01-19	handle (hot)	1	20
4	90 90 03 175 00 90	top	1	2
5	09 31 11 040 90	pin	1	2
6	09 24 03 193 90	adaptor	1	2
7	09 30 30 047 90	screw	1	2
8	09 14 10 139 90	seal	4	2
9	04 28 22 022 10 90	connection	2	2
10	04 31 11 002 00 90	pin	1	2
11	04 28 22 028 00-19	pipe	1	60
12	90 27 80 033 00-19	rosette	1	20
13	09 14 10 084 90	seal	1	2
14	09 14 10 018 90	seal	1	2