

Single-lever bath mixer with stand pipe for free-standing assembly with hand shower set - Dark Chrome

TARA

25 863 661















Fits: TARA, META

- spout: circular, air-enriched flow
- max. flow 19.5 l/min at 3 bar flow pressure
- Hand shower: COMPACT RAIN, max. flow rate 6.8 l/min (at 3 bar)
- bar-type hand shower with anti-scale system
- pivotable spout 360°
- 281mm projection
- wall bracket
- automatic bath/shower diverter
- total height 1031 - 1101 mm
- stand pipe height 565 - 635 mm
- height up to aerator 899 – 969 mm
- slide-on rosettes Ø 135 mm
- metal shower hose 1250mm with integrated anti-twist protection
- WRAS 2001027

Note: Local building codes may require the use of an anti-scald device. Please refer to remote pressure balance valve (35 910 970 90)

Intrinsic protection against back flow.

	Dark Chrome	25 863 661-19
	Chrome	25 863 661-00
	Brushed Platinum	25 863 661-06
	Light Gold	25 863 661-26
	Brushed Light Gold	25 863 661-27
	Brushed Durabronze (23kt Gold)	25 863 661-28
	Matte Black	25 863 661-33
	Brushed Bronze	25 863 661-42
	Brushed Champagne (22kt Gold)	25 863 661-46
	Champagne (22kt Gold)	25 863 661-47
	Brushed Chrome	25 863 661-93
	Brushed Dark Platinum	25 863 661-99

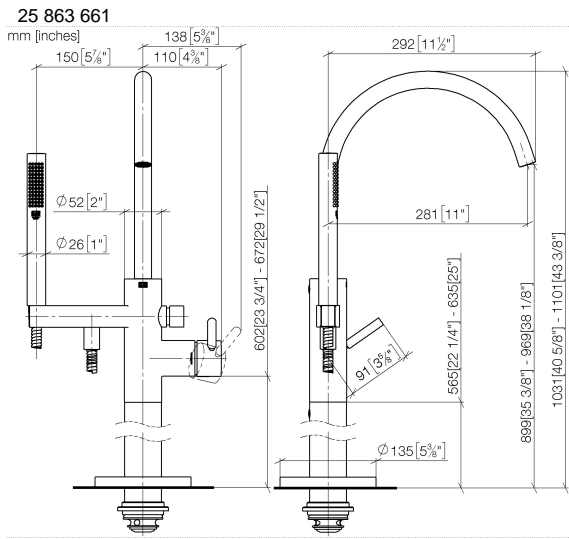

Flow rate chart

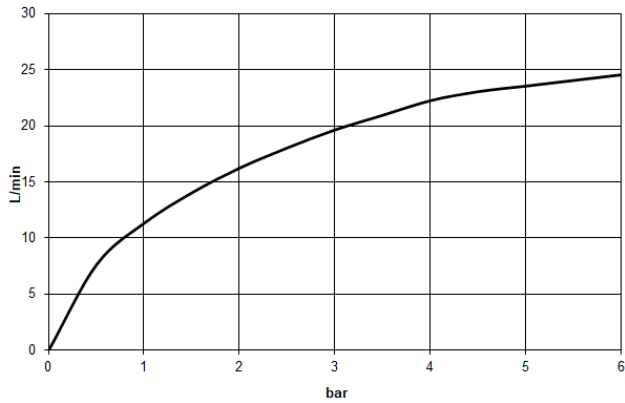

Codes & Standards

ASME A112.18.1/CSA B125.1	California Energy Commission (CEC)
---------------------------------	--

Single-lever bath mixer with stand pipe for free-standing assembly with hand shower set - Dark Chrome

TARA

25 863 661
Parts for other
finishes can be found
here: [Chrome](#)

