

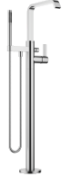







IMO Single-lever bath mixer with stand pipe for free-standing assembly with hand shower set - Brushed Chrome

IMO

25 863 671



- 279mm projection
- spout: cascade
- Hand shower: COMPACT RAIN, max. flow rate 6.8 l/min (at 3 bar)
- bar-type hand shower with anti-scale system
- wall bracket
- automatic bath/shower diverter
- total height 943 - 1013 mm
- stand pipe height 548 - 618 mm
- height up to aerator 891 – 961 mm
- metal shower hose 1250mm with integrated anti-twist protection
- max. flow for complete hand shower set 6.8 l/min
- slide-on rosettes Ø 135 mm

	Brushed Chrome	25 863 671-93
	Chrome	25 863 671-00
	Brushed Platinum	25 863 671-06
	Dark Chrome	25 863 671-19
	Brushed Light Gold	25 863 671-27
	Matte Black	25 863 671-33
	Brushed Dark Platinum	25 863 671-99

Required miscellaneous



- Concealed floor mounting -** 35 949 970-90
- min. recess depth 80 mm
 - max. recess depth 150 mm
- 0010

25 863 671

mm [inches]

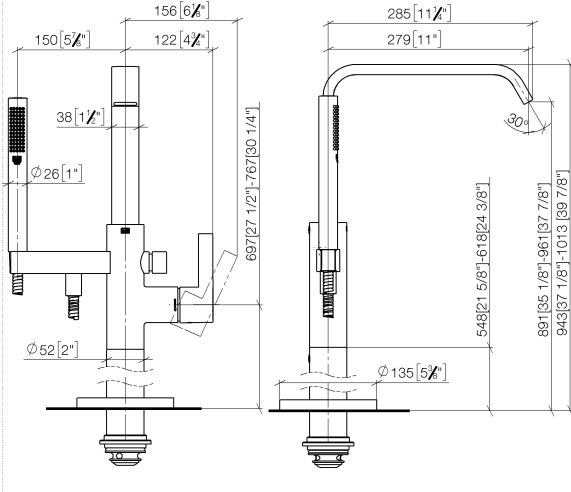

Flow rate chart

