

Profi spray set - Brushed Platinum

LOT

27 784 970









- spray flow
- automatic diverter for spout/Profi spray set
- height of mixer 665 mm
- individual rosette 55 x 55 mm
- profi spray hole diameter 30mm
- sprayface with anti-scaling system
- suspended spray with stainless steel spring (can be pivoted and locked)
- lead-free

The profi spray can be installed either with or without a rosette

Can only be combined with 32800680, 32843680.

Intrinsic protection against back flow.

Button has to be pressed while using.

	Brushed Platinum	27 784 970-06 0010
	Chrome	27 784 970-00 0010
	Platinum	27 784 970-08 0010
	Dark Chrome	27 784 970-19 0010
	Brushed Chrome	27 784 970-93 0010
	Brushed Dark Platinum	27 784 970-99 0010

27 784 970

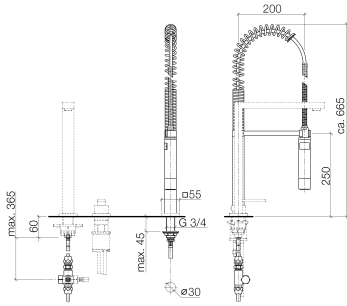

Flow rate chart



Codes & Standards

NSF/ANSI 372



Profi spray set - Brushed Platinum

LOT

27 784 970

Certificates

IAPMO_6397.

27 784 970

Parts for other finishes can be found here: [Chrome](#)

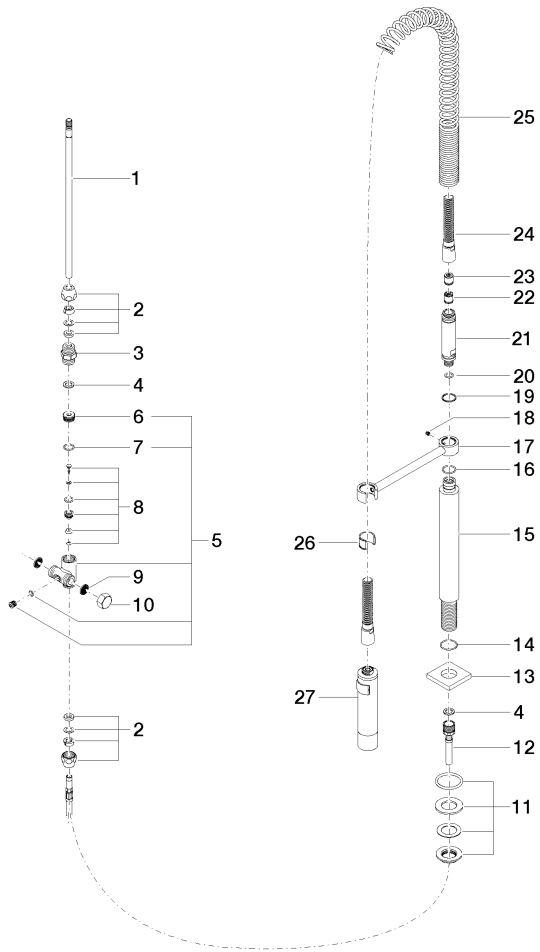



Profi spray set - Brushed Platinum

LOT

27 784 970

Spare parts list

No.	Item Number	Name	Quantity used	Delivery time
1	04 24 02 046 01-07	pipe	1	10
2	90 23 30 040 00-06	threaded connector	2	10
3	90 24 03 168 00 90	nipple	1	2
4	90 14 20 002 00 90	seal	2	2
5	90 17 09 046 10 90	diverter	1	2
6	09 24 04 112 10 90	nipple	1	2
7	90 14 10 033 00 90	seal	1	2
8	90 21 10 031 10 90	diverter	1	2
9	09 23 01 039 90	sieve	2	2
10	04 21 02 006 00 92	cap	1	2
11	04 23 10 004 03 90	fixing set	1	2
12	09 30 04 067 90	hose	1	2
13	09 27 97 033-06	rosette	1	10
14	09 14 10 120 90	seal	1	2
15	09 11 10 066 10-06	connection	1	10
16	09 14 10 031 90	seal	1	2
17	04 17 20 014 00-06	holder	1	10
18	09 31 11 049 90	pin	1	2
19	09 14 15 012 90	ring	1	2
20	09 14 10 003 90	seal	1	2
21	09 30 01 067 10-06	adaptor	1	10
22	90 23 01 141 00 90	back-flow preventer	1	2
23	09 23 01 046 90	back-flow preventer	1	2
24	90 30 02 065 00-06	hose	1	10
25	09 16 02 034 90	spring	1	2
26	90 18 40 035 00 90	sleeve	1	2
27	04 12 11 094 10-06	shower	1	10