











27 802 970



Fits: IMO, MEM, CL.1, CYO

- COMPACT RAIN, max. flow rate 6.8 l/min (at 3 bar)
- with anti-scale system
- 3/8" shower outlet
- metal shower hose 1250mm with integrated anti-twist protection
- rosette 60 x 60 mm
- 1/2" connection
- This product reduces water consumption by % (compared to requirements of EPA Act '92)
- This product can contribute to Water Use Reduction in LEED® Green Building Rating
- This product can help a building meet the requirements of Green Building Rating Systems, e.g. LEED®, BREEAM®, DGNB

Intrinsic protection against back flow.

	Brushed Chrome	27 802 970-93 0010
	Chrome	27 802 970-00 0010
	Brushed Platinum	27 802 970-06 0010
	Platinum	27 802 970-08 0010
	Dark Chrome	27 802 970-19 0010
	Brushed Light Gold	27 802 970-27 0010
	Brushed Durabronze (23kt Gold)	27 802 970-28 0010
	Matte Black	27 802 970-33 0010
	Brushed Champagne (22kt Gold)	27 802 970-46 0010
	Champagne (22kt Gold)	27 802 970-47 0010
	Brushed Dark Platinum	27 802 970-99 0010

27 802 970

mm [inches]

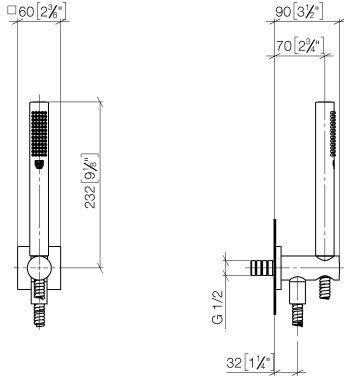

Codes & Standards

ASME
A112.18.1/CSA
B125.1

California Energy
Commission
(CEC)

Certificates

LGA_29985.

27 802 970

Parts for other finishes can be found here: [Chrome](#)

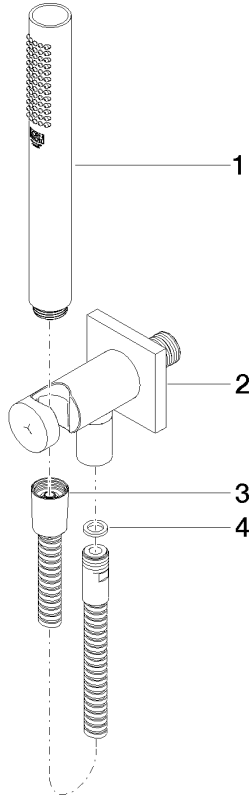

Spare parts list

No.	Item Number	Name	Quantity used	Delivery time
1	90 12 11 140 30-93	shower	1	20
2	28 490 970-93	Wall elbow with integrated shower holder - Brushed Chrome	1	20
3	90 30 02 072 00-93	Metal shower hose 1/2" x 3/8" x 1250 mm - Brushed Chrome	1	20
4	90 14 20 026 00 90	seal	1	2