













27 805 625



- COMPACT RAIN, max. flow rate 6.8 l/min (at 3 bar)
- spray head Ø 100mm
- three settings: normal flow, soft flow, massage flow
- with anti-scale system
- metal shower hose 1250mm with integrated anti-twist protection
- shower holder rosette Ø 55mm
- This product reduces water consumption by % (compared to requirements of EPAct '92)
- This product can contribute to Water Use Reduction in LEED® Green Building Rating
- This product can help a building meet the requirements of Green Building Rating Systems, e.g. LEED®, BREEAM®, DGNB

Intrinsic protection against back flow.

	Dark Chrome	27 805 625-19 0010
	Chrome	27 805 625-00 0010
	Brushed Platinum	27 805 625-06 0010
	Light Gold	27 805 625-26 0010
	Brushed Light Gold	27 805 625-27 0010
	Brushed Durabronze (23kt Gold)	27 805 625-28 0010
	Matte Black	27 805 625-33 0010
	Brushed Bronze	27 805 625-42 0010
	Brushed Champagne (22kt Gold)	27 805 625-46 0010
	Champagne (22kt Gold)	27 805 625-47 0010
	Brushed Chrome	27 805 625-93 0010
	Brushed Dark Platinum	27 805 625-99 0010

**Recommended miscellaneous**

**Concealed adapter -**

35 080 970-90  
0010



**Recommended miscellaneous**

**Wall elbow - Dark Chrome**

28 450 625-19



27 805 625

mm [inches]

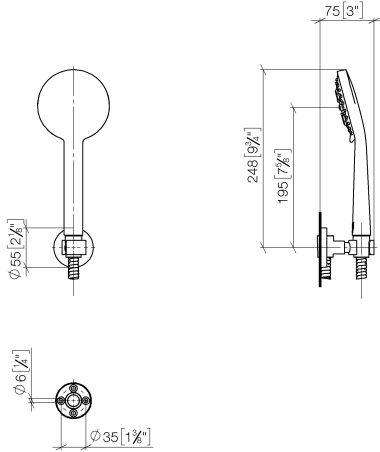

**Flow rate chart**



**Codes & Standards**

ASME  
A112.18.1/CSA  
B125.1

California Energy  
Commission  
(CEC)



## META Hand shower set FlowReduce - Dark Chrome

---

META

27 805 625

### Certificates

---

LGA\_29984.

27 805 625

