











27 805 625



- COMPACT RAIN, max. flow rate 6.8 l/min (at 3 bar)
- spray head Ø 100mm
- three settings: normal flow, soft flow, massage flow
- with anti-scale system
- metal shower hose 1250mm with integrated anti-twist protection
- shower holder rosette Ø 55mm
- This product reduces water consumption by % (compared to requirements of EPAAct '92)
- This product can contribute to Water Use Reduction in LEED® Green Building Rating
- This product can help a building meet the requirements of Green Building Rating Systems, e.g. LEED®, BREEAM®, DGNB

Intrinsic protection against back flow.

	Brushed Champagne (22kt Gold)	27 805 625-46 0010
	Chrome	27 805 625-00 0010
	Brushed Platinum	27 805 625-06 0010
	Dark Chrome	27 805 625-19 0010
	Light Gold	27 805 625-26 0010
	Brushed Light Gold	27 805 625-27 0010
	Brushed Durabrass (23kt Gold)	27 805 625-28 0010
	Matte Black	27 805 625-33 0010
	Brushed Bronze	27 805 625-42 0010
	Champagne (22kt Gold)	27 805 625-47 0010
	Brushed Chrome	27 805 625-93 0010
	Brushed Dark Platinum	27 805 625-99 0010

Recommended miscellaneous



Wall elbow - Brushed Champagne (22kt Gold) 28 450 625-46

27 805 625

mm [inches]

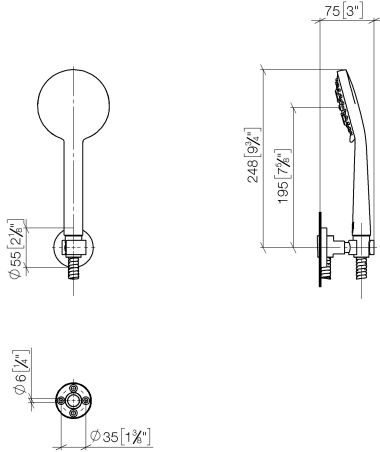

Flow rate chart

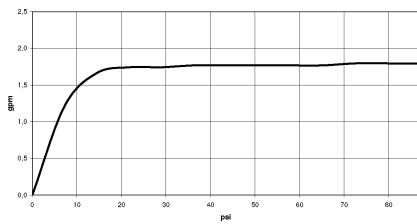

Codes & Standards

ASME	California Energy
A112.18.1/CSA	Commission
B125.1	(CEC)



META Hand shower set FlowReduce - Brushed Champagne (22kt Gold)

META

27 805 625

Certificates

LGA_29984.

27 805 625

Parts for other
finishes can be found
here: [Chrome](#)

