

Affusion pipe with cover plate - Brushed Chrome

IMO









27 838 979



Fits: IMO, MEM, CL.1, CYO

- LAMINAR FLOW, max. flow rate 15 l/min (at 3 bar)
 - 3/8" shower outlet
 - cover plate 240 x 60 mm
 - metal shower hose 1250mm with integrated anti-twist protection
 - 1/2" connection
 - plug-link mounting
- Intrinsic protection against back flow.**

Intrinsic protection against back flow.

	Brushed Chrome	27 838 979-93
	Chrome	27 838 979-00
	Brushed Platinum	27 838 979-06
	Platinum	27 838 979-08
	Dark Chrome	27 838 979-19
	Brushed Light Gold	27 838 979-27
	Brushed Durabronze (23kt Gold)	27 838 979-28
	Matte Black	27 838 979-33
	Brushed Dark Platinum	27 838 979-99

Required miscellaneous

Concealed adapter -

35 080 970-90
0010



27 838 979

mm [inches]



Flow rate chart



Codes & Standards

DIN 4109

EN 1717

ISO 3822

Ü-Zeichen



Affusion pipe with cover plate - Brushed Chrome

IMO

27 838 979

Certificates

Belgaqua_21-023-2 LGA_38

27 838 979

Product version up to 3/2/2021

Product version from 3/2/2021

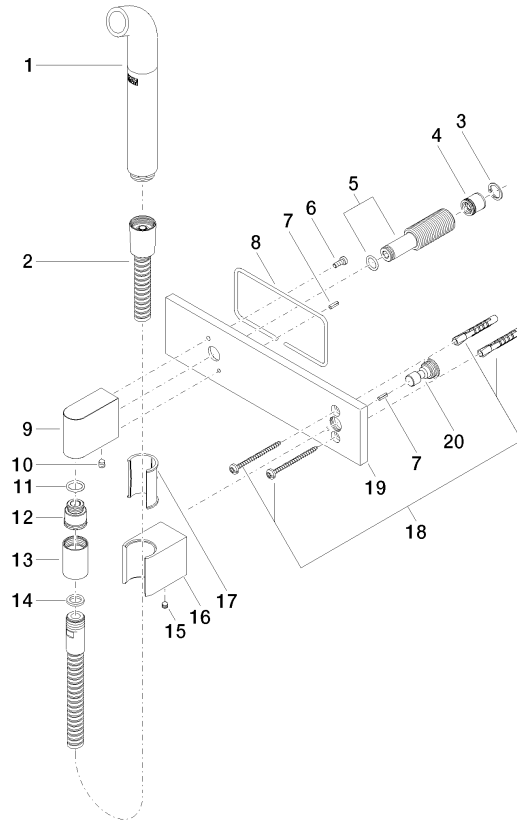



Affusion pipe with cover plate - Brushed Chrome

IMO

27 838 979

Spare parts list

Product version up to 3/2/2021

Product version from 3/2/2021

No.	Item Number	Name	Quantity used	Delivery time
	04 12 11 073 01-93	spout	21	20