







28 450 845



- 3/8" shower outlet
 - rosette 60 x 78 mm
 - 1/2" connection
 - WRAS 2310091
- Intrinsic protection against back flow.**

Intrinsic protection against back flow.

	Brushed Platinum	28 450 845-06
	Chrome	28 450 845-00
	Dark Chrome	28 450 845-19
	Brushed Light Gold	28 450 845-27
	Matte Black	28 450 845-33
	Brushed Chrome	28 450 845-93
	Brushed Dark Platinum	28 450 845-99

Required miscellaneous

Concealed adapter -

35 080 970-90
0010



28 450 845

mm [inches]

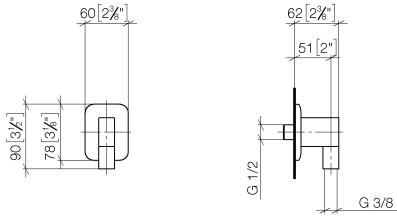

Flow rate chart



Codes & Standards

ASME
A112.18.1/CSA
B125.1



LISSÉ Wall elbow - Brushed Platinum

LISSÉ

28 450 845

Certificates

IAPMO_4976 (5). WRAS_2310091.

28 450 845

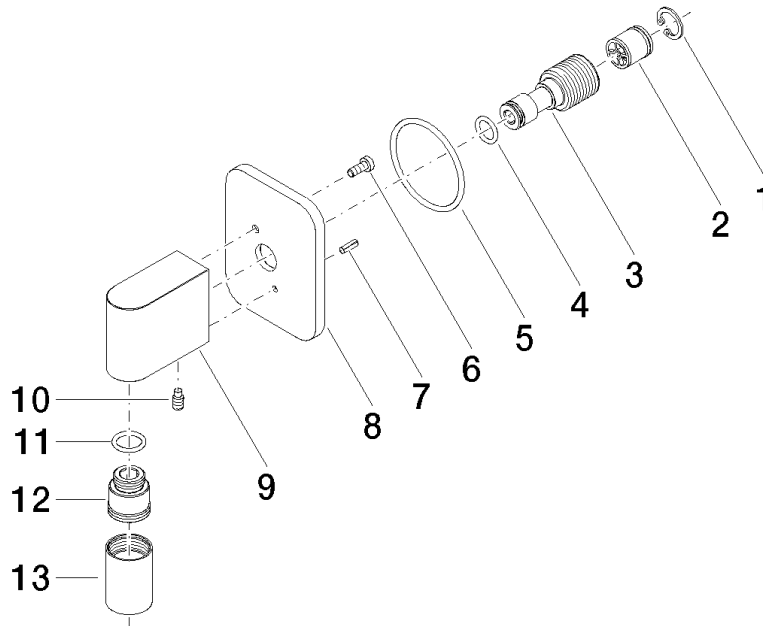

Spare parts list

No.	Item Number	Name	Quantity used	Delivery time
1	09 16 01 014 90	ring	1	2
2	90 23 01 141 00 90	back-flow preventer	1	2
3	09 24 03 116 20 90	nipple	1	2
4	09 14 10 008 90	seal	1	2
5	09 14 10 142 90	seal	1	2
6	09 30 30 054 90	screw	1	2
7	09 31 11 026 90	pin	1	2
8	09 27 84 021-06	rosette	1	10
9	09 11 03 046-06	connection	1	10
10	09 31 11 005 90	pin	1	2
11	90 14 10 077 00 90	seal	1	2
12	09 24 03 107 20 90	nipple	1	2
13	90 21 02 069 00-06	cover	1	10