













28 504 979



Fits: TARA, LISSÉ, VAIA, META

- 180-210mm projection
- ball-joint pivotable through 30°
- PURIFY RAIN, max. flow rate 6.8 l/min (at 3 bar)
- with anti-scale system
- spray head Ø 100mm
- rosette Ø 55 mm
- 1/2" connection
- This product reduces water consumption by % (compared to requirements of EAct '92)
- This product can help a building meet the requirements of Green Building Rating Systems, e.g. LEED®, BREEAM®, DGNB

	Brushed Platinum	28 504 979-06 0010
	Chrome	28 504 979-00 0010
	Platinum	28 504 979-08 0010
	Dark Chrome	28 504 979-19 0010
	Light Gold	28 504 979-26 0010
	Brushed Light Gold	28 504 979-27 0010
	Brushed Durabronze (23kt Gold)	28 504 979-28 0010
	Matte Black	28 504 979-33 0010
	Brushed Bronze	28 504 979-42 0010
	Brushed Champagne (22kt Gold)	28 504 979-46 0010
	Champagne (22kt Gold)	28 504 979-47 0010
	Brushed Chrome	28 504 979-93 0010
	Brushed Dark Platinum	28 504 979-99 0010



Shower head - Brushed Platinum

TARA

28 504 979

mm [inches]

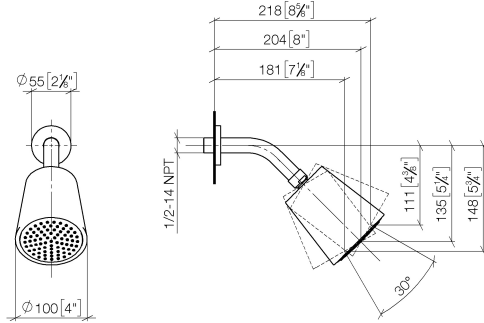

Flow rate chart



Codes & Standards

ASME
A112.18.1/CSA
B125.1

California Energy
Commission
(CEC)

Water Sense





Shower head - Brushed Platinum

TARA

28 504 979

Certificates

IAPMO_11777.

IAPMO_4976 (4).

28 504 979

Parts for other finishes can be found here: [Chrome](#)

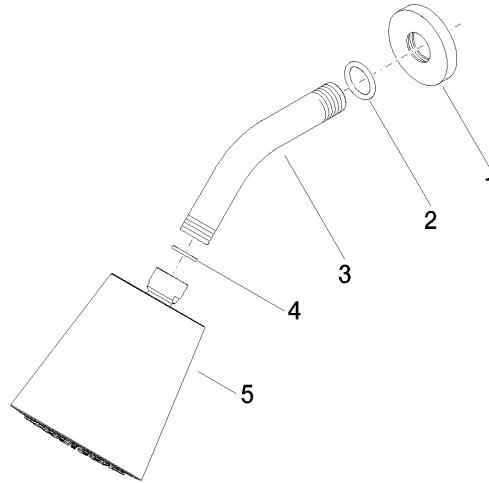

Spare parts list

No.	Item Number	Name	Quantity used	Delivery time
1	09 27 22 003-06	rosette	1	10
2	90 14 10 026 00 90	seal	1	2
3	09 11 03 011-06	connection	1	10
4	90 14 20 002 00 90	seal	1	2
5	90 12 05 054 01-06	shower	1	10