

Rain shower with wall fixing 220 mm - Champagne (22kt Gold)













TARA

28 649 970



Fits: TARA, LISSÉ, VAIA, META

- 450mm projection
- PURE RAIN, max. flow rate 6.8 l/min (at 3 bar)
- Function from: 6 l/min
- with anti-scale system
- rain shower Ø 220 mm
- rosette Ø 60 mm
- 1/2" connection
- quick clearing
- This product reduces water consumption by % (compared to requirements of EPAAct '92)
- This product can contribute to Water Use Reduction in LEED® Green Building Rating
- This product can help a building meet the requirements of Green Building Rating Systems, e.g. LEED®, BREEAM®, DGNB

	Champagne (22kt Gold)	28 649 970-47 0010
	Chrome	28 649 970-00 0010
	Brushed Platinum	28 649 970-06 0010
	Platinum	28 649 970-08 0010
	Dark Chrome	28 649 970-19 0010
	Light Gold	28 649 970-26 0010
	Brushed Light Gold	28 649 970-27 0010
	Brushed Durabronze (23kt Gold)	28 649 970-28 0010
	Matte Black	28 649 970-33 0010
	Brushed Bronze	28 649 970-42 0010
	Brushed Champagne (22kt Gold)	28 649 970-46 0010
	Brushed Chrome	28 649 970-93 0010
	Brushed Dark Platinum	28 649 970-99 0010

Required miscellaneous

	Concealed wall elbow - •max. recess depth 163 mm •min. recess depth 90 mm	35 085 970-90 0010
---	--	-----------------------

28 649 970

mm [inches]

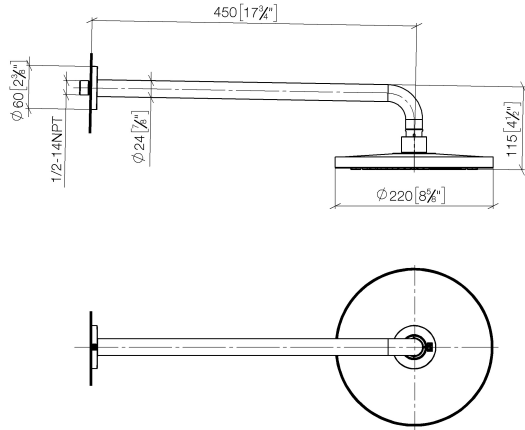

Flow rate chart



Codes & Standards

ASME	California Energy
A112.18.1/CSA	Commission
B125.1	(CEC)

28 649 970

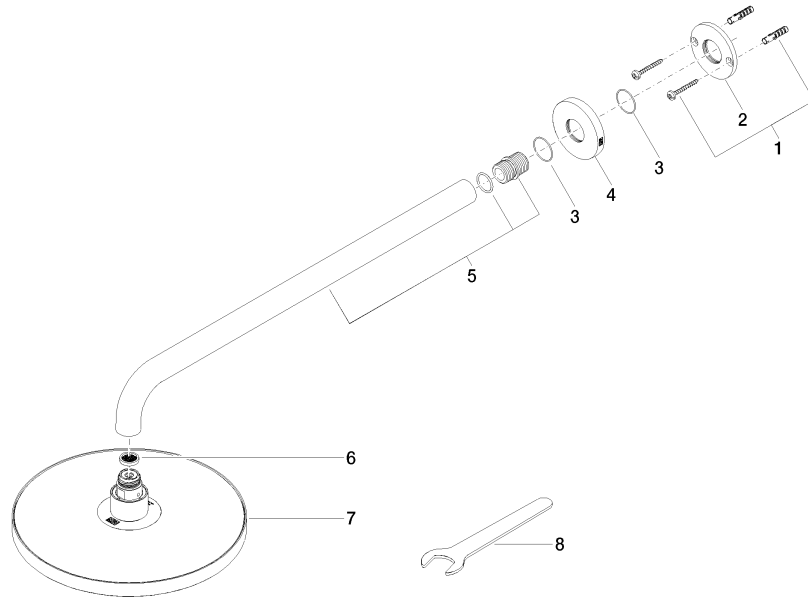

Spare parts list

No.	Item Number	Name	Quantity used	Delivery time
1	04 30 31 032 00 90	fixing set	1	2
2	09 17 20 120 90	holder	1	2
3	09 14 10 150 90	seal	2	2
4	09 27 97 015-47	rosette	1	30
5	90 11 03 070 00-47	pipe	1	30
6	09 23 01 075 90	insert	1	2
7	04 12 05 092 10-47	shower	1	60
8	90 30 09 069 00 90	key	1	2