

## Rain shower with wall fixing 300 mm - Platinum













TARA

28 679 970



Fits: TARA, LISSÉ, VAIA, META

- 450mm projection
- PURE RAIN, max. flow rate 6.8 l/min (at 3 bar)
- Function from: 6.5 l/min
- with anti-scale system
- rain shower Ø 300 mm
- rosette Ø 60 mm
- 1/2" connection
- quick clearing
- This product reduces water consumption by % (compared to requirements of EPAAct '92)
- This product can contribute to Water Use Reduction in LEED® Green Building Rating
- This product can help a building meet the requirements of Green Building Rating Systems, e.g. LEED®, BREEAM®, DGNB

|   |                                |                    |
|---|--------------------------------|--------------------|
|    | Platinum                       | 28 679 970-08 0010 |
|    | Chrome                         | 28 679 970-00 0010 |
|    | Brushed Platinum               | 28 679 970-06 0010 |
|    | Dark Chrome                    | 28 679 970-19 0010 |
|    | Light Gold                     | 28 679 970-26 0010 |
|    | Brushed Light Gold             | 28 679 970-27 0010 |
|    | Brushed Durabronze (23kt Gold) | 28 679 970-28 0010 |
|    | Matte Black                    | 28 679 970-33 0010 |
|    | Brushed Bronze                 | 28 679 970-42 0010 |
|   | Brushed Champagne (22kt Gold)  | 28 679 970-46 0010 |
|  | Champagne (22kt Gold)          | 28 679 970-47 0010 |
|  | Brushed Chrome                 | 28 679 970-93 0010 |
|  | Brushed Dark Platinum          | 28 679 970-99 0010 |

### Required miscellaneous



- |                               |               |
|-------------------------------|---------------|
| <b>Concealed wall elbow -</b> | 35 085 970-90 |
| •max. recess depth 163 mm     | 0010          |
| •min. recess depth 90 mm      |               |

28 679 970

mm [inches]

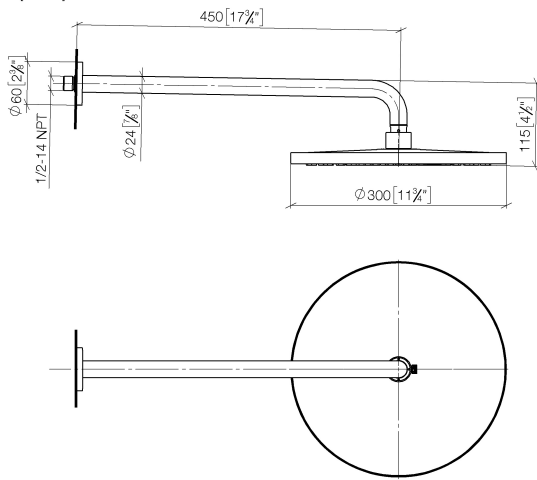

Flow rate chart

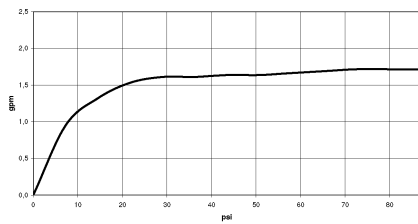

Codes & Standards

ASME  
A112.18.1/CSA  
B125.1

California Energy  
Commission  
(CEC)

Water Sense





## Rain shower with wall fixing 300 mm - Platinum

---

TARA

28 679 970

### Certificates

---

IAPMO\_11777.

IAPMO\_4976 (4).

28 679 970

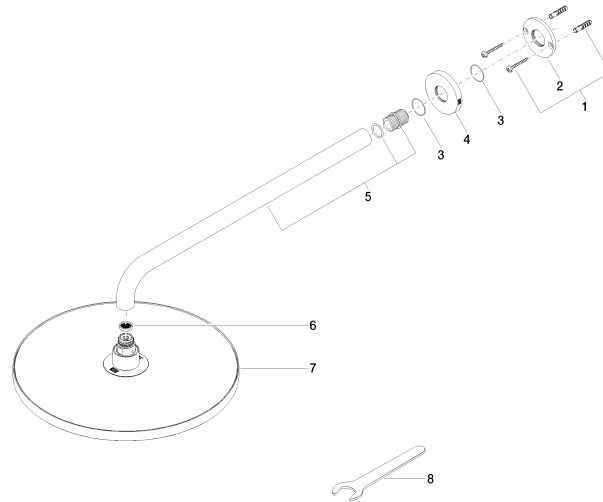

### Spare parts list

| No. | Item Number        | Name       | Quantity used | Delivery time |
|-----|--------------------|------------|---------------|---------------|
| 1   | 04 30 31 032 00 90 | fixing set | 1             | 2             |
| 2   | 09 17 20 120 90    | holder     | 1             | 2             |
| 3   | 09 14 10 150 90    | seal       | 2             | 2             |
| 4   | 09 27 97 015-08    | rosette    | 1             | 40            |
| 5   | 90 11 03 070 00-08 | pipe       | 1             | 40            |
| 6   | 09 23 01 075 90    | insert     | 1             | 2             |
| 7   | 04 12 05 091 10-08 | shower     | 1             | 40            |
| 8   | 90 30 09 069 00 90 | key        | 1             | 2             |