

Rain shower with wall fixing 300 mm - Brushed Chrome













TARA

28 679 970



Fits: TARA, LISSÉ, VAIA, META

- 450mm projection
- PURE RAIN, max. flow rate 6.8 l/min (at 3 bar)
- Function from: 6.5 l/min
- with anti-scale system
- rain shower Ø 300 mm
- rosette Ø 60 mm
- 1/2" connection
- quick clearing
- This product reduces water consumption by % (compared to requirements of EPAAct '92)
- This product can contribute to Water Use Reduction in LEED® Green Building Rating
- This product can help a building meet the requirements of Green Building Rating Systems, e.g. LEED®, BREEAM®, DGNB

	Brushed Chrome	28 679 970-93 0010
	Chrome	28 679 970-00 0010
	Brushed Platinum	28 679 970-06 0010
	Platinum	28 679 970-08 0010
	Dark Chrome	28 679 970-19 0010
	Light Gold	28 679 970-26 0010
	Brushed Light Gold	28 679 970-27 0010
	Brushed Durabronze (23kt Gold)	28 679 970-28 0010
	Matte Black	28 679 970-33 0010
	Brushed Bronze	28 679 970-42 0010
	Brushed Champagne (22kt Gold)	28 679 970-46 0010
	Champagne (22kt Gold)	28 679 970-47 0010
	Brushed Dark Platinum	28 679 970-99 0010

28 679 970

mm [inches]

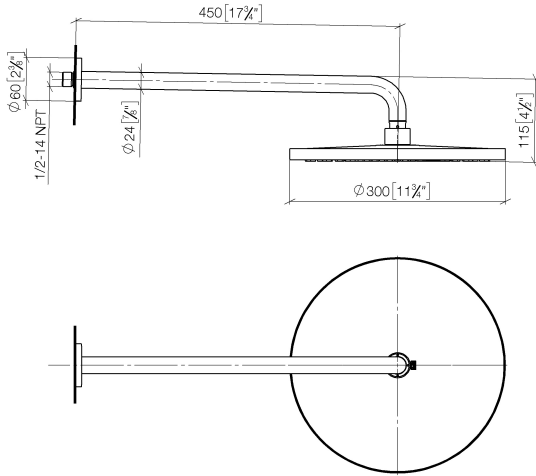

Flow rate chart

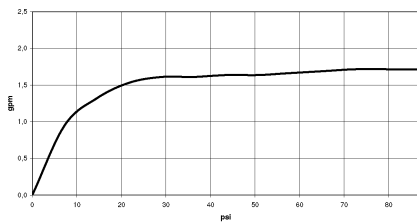

Codes & Standards

ASME
A112.18.1/CSA
B125.1

California Energy
Commission
(CEC)

Water Sense





Rain shower with wall fixing 300 mm - Brushed Chrome

TARA

28 679 970

Certificates

IAPMO_11777.

IAPMO_4976 (2).

28 679 970

Parts for other finishes can be found here: [Chrome](#)

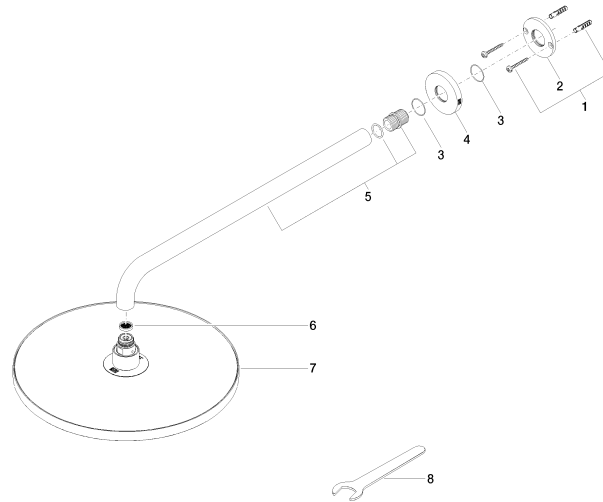

Spare parts list

No.	Item Number	Name	Quantity used	Delivery time
1	04 30 31 032 00 90	fixing set	1	2
2	09 17 20 120 90	holder	1	2
3	09 14 10 150 90	seal	2	2
4	09 27 97 015-93	rosette	1	20
5	90 11 03 070 00-93	pipe	1	20
6	09 23 01 075 90	insert	1	2
7	04 12 05 091 10-93	shower	1	20
8	90 30 09 069 00 90	key	1	2