











30 010 662



- 126mm projection
- fixed spout
- circular, air-enriched flow
- hole diameter 35 mm
- rosette Ø 60 mm
- max. flow 4.5 l/min
- lead-free
- This product can help a building meet the requirements of Green Building Rating Systems, e.g. LEED®, BREEAM®, DGNB

	Brushed Chrome	30 010 662-93 0010
	Chrome	30 010 662-00 0010
	Brushed Platinum	30 010 662-06 0010
	Light Gold	30 010 662-26 0010
	Brushed Light Gold	30 010 662-27 0010
	Matte Black	30 010 662-33 0010
	Brushed Bronze	30 010 662-42 0010
	Brushed Champagne (22kt Gold)	30 010 662-46 0010
	Champagne (22kt Gold)	30 010 662-47 0010
	Brushed Dark Platinum	30 010 662-99 0010

**Recommended miscellaneous**



- Concealed wall elbow -** 35 085 970-90  
 •max. recess depth 163 mm 0010  
 •min. recess depth 90 mm

30 010 662

mm [inches]

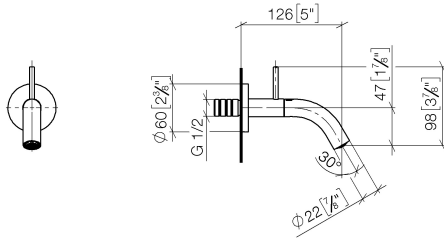

**Flow rate chart**

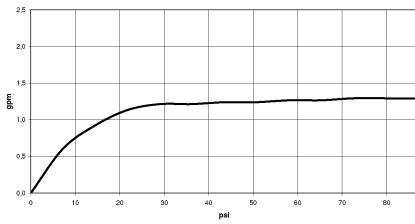

**Codes & Standards**

California Energy  
Commission  
(CEC)

Water Sense





## META Wall-mounted valve cold water without pop-up waste - Brushed Chrome

---

META

30 010 662

### Certificates

---

IAPMO\_8834 (2).    IAPMO\_N-4976.    IAPMO\_4976 (7).    IAPMO\_6397.

30 010 662

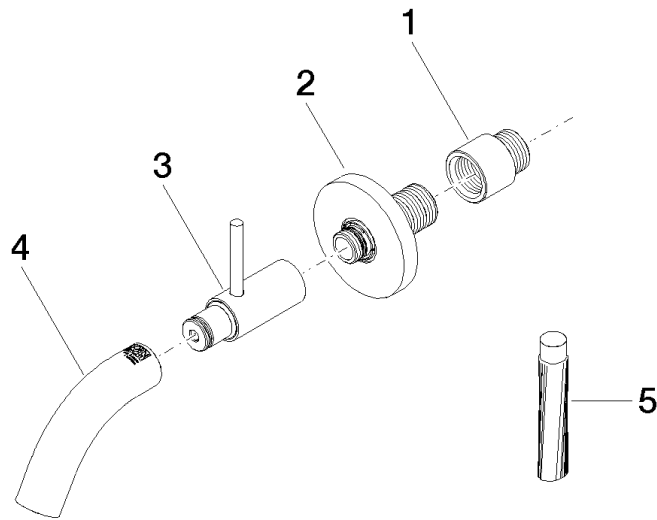

**Spare parts list**

No.	Item Number	Name	Quantity used	Delivery time
1	09 24 03 072 10 90	nipple	1	2
2	90 27 66 019 00-93	rosette	1	20
3	90 20 66 023 00-93	handle	1	20
4	90 28 22 386 00-93	spout	1	20
5	09 16 03 001 90	grease	1	2