







33 500 845



- 130mm projection
- 1 1/4" pop-up waste
- fixed spout
- circular, air-enriched flow
- height of mixer 127 mm
- height up to aerator 75 mm
- hole diameter 35 mm
- 2 x pressure hose with 3/8" cap nut
- max. flow 4.5 l/min
- lead-free
- This product can help a building meet the requirements of Green Building Rating Systems, e.g. LEED®, BREEAM®, DGNB

Only suitable for basins with an overflow.

	Chrome	33 500 845-00 0010
	Brushed Platinum	33 500 845-06 0010
	Dark Chrome	33 500 845-19 0010
	Matte Black	33 500 845-33 0010
	Brushed Chrome	33 500 845-93 0010
	Brushed Dark Platinum	33 500 845-99 0010

33 500 845

mm [inches]

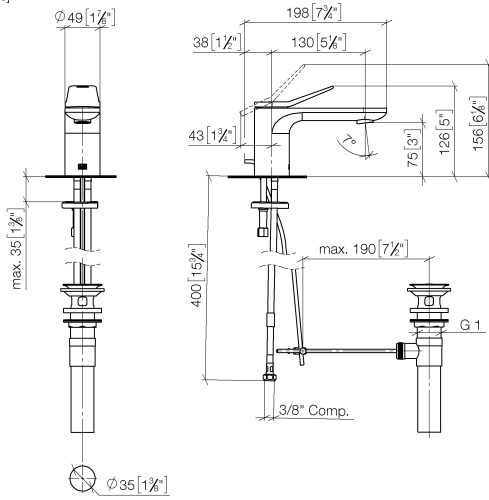

Flow rate chart

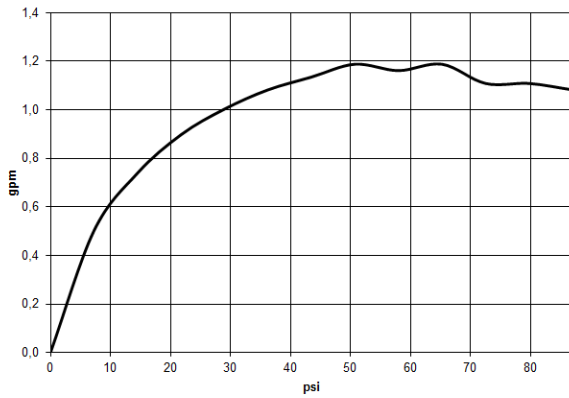

Codes & Standards

ADA

ASME
A112.18.1/CSA
B125.1

California Energy
Commission
(CEC)

NSF/ANSI 372

NSF/ANSI/CAN
61

Water Sense





LISSÉ Single-lever basin mixer with pop-up waste - Chrome

LISSÉ

33 500 845

Certificates

IAPMO_8834 (2). IAPMO_N-4976 (1). IAPMO_4976 (3). IAPMO_6397 (1).

33 500 845

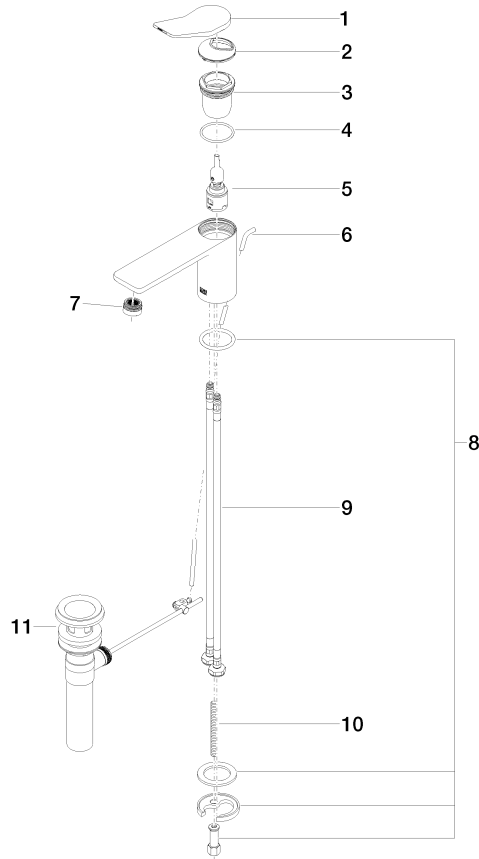

Spare parts list

No.	Item Number	Name	Quantity used	Delivery time
1	90 20 84 020 00-00	handle	1	10
2	09 28 30 034 90	cover	1	2
3	09 23 10 123 90	nut	1	2
4	09 14 10 038 90	seal	1	2
5	90 15 05 042 01 90	cartridge	1	2
6	09 31 09 120-00	pull-rod	1	10
7	90 23 01 161 03-00	aerator	1	10
8	04 30 11 038 75 90	fixing set	1	2
9	04 30 04 102 00 90	High pressure hose 3/8" -	2	2
10	09 31 11 011 90	pin	1	2
11	90 11 01 023 00-00	pop-up waste	1	10