

**META META SLIM Single-lever basin mixer with pop-up waste - Brushed  
Champagne (22kt Gold)**















META

33 501 662



- 125mm projection
- 1 1/4" pop-up waste
- fixed spout
- circular, air-enriched flow
- height of mixer 134 mm
- height up to aerator 52 mm
- hole diameter 35 mm
- 2 x pressure hose with 3/8" cap nut
- max. flow 4.5 l/min
- lead-free
- This product can help a building meet the requirements of Green Building Rating Systems, e.g. LEED®, BREEAM®, DGNB

Only suitable for basins with an overflow.

	Brushed Champagne (22kt Gold)	33 501 662-46 0010
	Chrome	33 501 662-00 0010
	Brushed Platinum	33 501 662-06 0010
	Platinum	33 501 662-08 0010
	Dark Chrome	33 501 662-19 0010
	Light Gold	33 501 662-26 0010
	Brushed Light Gold	33 501 662-27 0010
	Brushed Durabrass (23kt Gold)	33 501 662-28 0010
	Red	33 501 662-29 0010
	Orange	33 501 662-30 0010
	Dark Green	33 501 662-31 0010
	Matte Black	33 501 662-33 0010
	Brushed Bronze	33 501 662-42 0010
	Champagne (22kt Gold)	33 501 662-47 0010
	Brushed Chrome	33 501 662-93 0010
	Brushed Dark Platinum	33 501 662-99 0010



**META META SLIM Single-lever basin mixer with pop-up waste - Brushed Champagne (22kt Gold)**

META

33 501 662  
mm [inches]

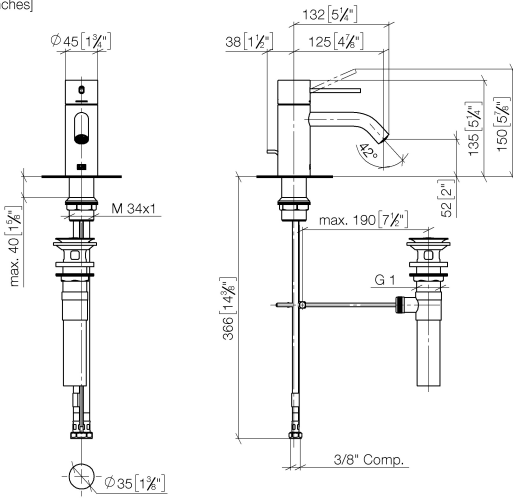

**Flow rate chart**

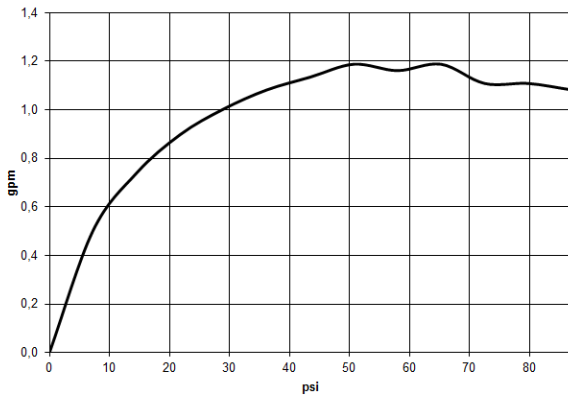

**Codes & Standards**

ADA

ASME  
A112.18.1/CSA  
B125.1

California Energy  
Commission  
(CEC)

NSF/ANSI 372

NSF/ANSI/CAN  
61



META META SLIM Single-lever basin mixer with pop-up waste - Brushed  
Champagne (22kt Gold)

---

META

33 501 662

Certificates

---

IAPMO\_N-4976 (1). IAPMO\_6397 (1).

META META SLIM Single-lever basin mixer with pop-up waste - Brushed  
Champagne (22kt Gold)

META

33 501 662

Parts for other  
finishes can be found  
here: [Chrome](#)

