

META META SLIM Single-lever basin mixer with pop-up waste - Champagne (22kt Gold)

















META

33 501 662



- 125mm projection
- 1 1/4" pop-up waste
- fixed spout
- circular, air-enriched flow
- height of mixer 134 mm
- height up to aerator 52 mm
- hole diameter 35 mm
- 2 x pressure hose with 3/8" cap nut
- max. flow 4.5 l/min
- lead-free
- This product can help a building meet the requirements of Green Building Rating Systems, e.g. LEED®, BREEAM®, DGNB

Only suitable for basins with an overflow.

	Champagne (22kt Gold)	33 501 662-47 0010
	Chrome	33 501 662-00 0010
	Brushed Platinum	33 501 662-06 0010
	Platinum	33 501 662-08 0010
	Dark Chrome	33 501 662-19 0010
	Light Gold	33 501 662-26 0010
	Brushed Light Gold	33 501 662-27 0010
	Brushed Durabronze (23kt Gold)	33 501 662-28 0010
	Red	33 501 662-29 0010
	Orange	33 501 662-30 0010
	Dark Green	33 501 662-31 0010
	Matte Black	33 501 662-33 0010
	Brushed Bronze	33 501 662-42 0010
	Brushed Champagne (22kt Gold)	33 501 662-46 0010
	Brushed Chrome	33 501 662-93 0010
	Brushed Dark Platinum	33 501 662-99 0010

33 501 662
mm [inches]

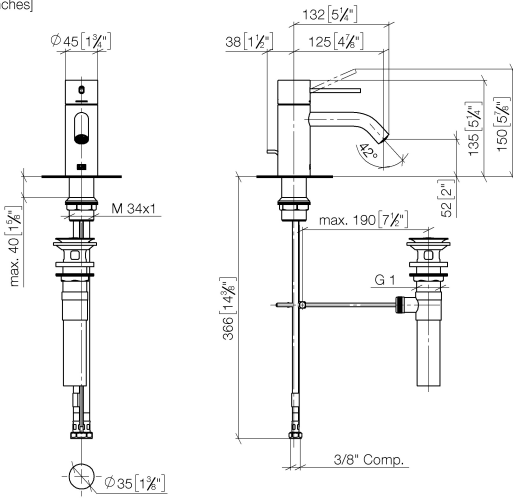

Flow rate chart

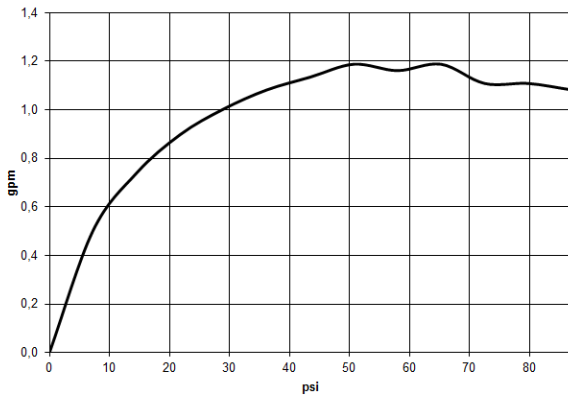

Codes & Standards

ADA

ASME
A112.18.1/CSA
B125.1

California Energy
Commission
(CEC)

NSF/ANSI 372

NSF/ANSI/CAN
61

Water Sense





META META SLIM Single-lever basin mixer with pop-up waste - Champagne
(22kt Gold)

META

33 501 662

Certificates

IAPMO_8834 (2). IAPMO_N-4976 (1). IAPMO_6397 (1).

META META SLIM Single-lever basin mixer with pop-up waste - Champagne
(22kt Gold)

META

33 501 662
Parts for other
finishes can be found
here: [Chrome](#)

