















META Single-lever basin mixer without pop-up waste - Champagne (22kt Gold)

META

33 525 660



- 105mm projection
- fixed spout
- circular, air-enriched flow
- height of mixer 138 mm
- height up to aerator 57 mm
- hole diameter 35 mm
- rosette Ø 50 mm optional
- 2 x pressure hose with 3/8" cap nut
- max. flow 4.5 l/min
- lead-free
- This product can help a building meet the requirements of Green Building Rating Systems, e.g. LEED®, BREEAM®, DGNB

	Champagne (22kt Gold)	33 525 660-47 0010
	Chrome	33 525 660-00 0010
	Brushed Platinum	33 525 660-06 0010
	Platinum	33 525 660-08 0010
	Dark Chrome	33 525 660-19 0010
	Light Gold	33 525 660-26 0010
	Brushed Light Gold	33 525 660-27 0010
	Brushed Durabronze (23kt Gold)	33 525 660-28 0010
	Red	33 525 660-29 0010
	Orange	33 525 660-30 0010
	Dark Green	33 525 660-31 0010
	Matte Black	33 525 660-33 0010
	Brushed Bronze	33 525 660-42 0010
	Brushed Champagne (22kt Gold)	33 525 660-46 0010
	Brushed Chrome	33 525 660-93 0010
	Brushed Dark Platinum	33 525 660-99 0010



META Single-lever basin mixer without pop-up waste - Champagne (22kt Gold)

META

33 525 660

mm [inches]

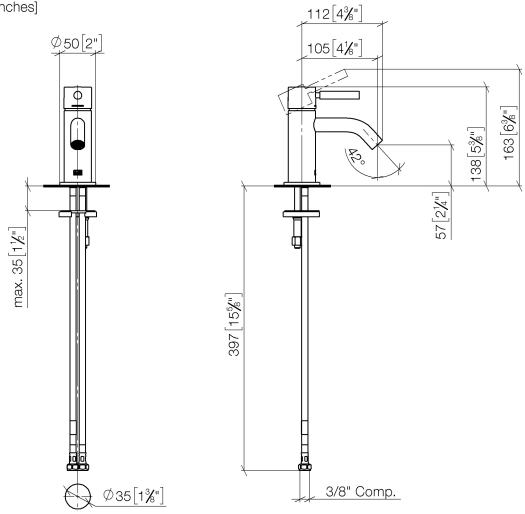

Flow rate chart

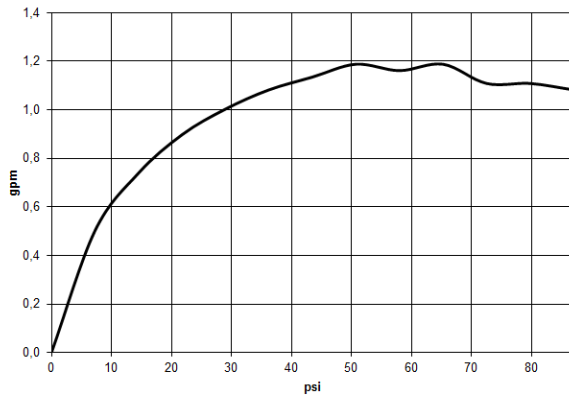

Codes & Standards

ADA	ASME A112.18.1/CSA B125.1	California Energy Commission (CEC)	EPA WaterSense
NSF/ANSI 372	NSF/ANSI/CAN 61	NSF372	NSF61
Water Sense	WaterSense		



META Single-lever basin mixer without pop-up waste - Champagne (22kt Gold)

META

33 525 660

Certificates

IAPMO_8834

IAPMO_6397

IAPMO_N-4976

33 525 660

Product version from 1/23/2020

Parts for other finishes can be found here: [Chrome](#)

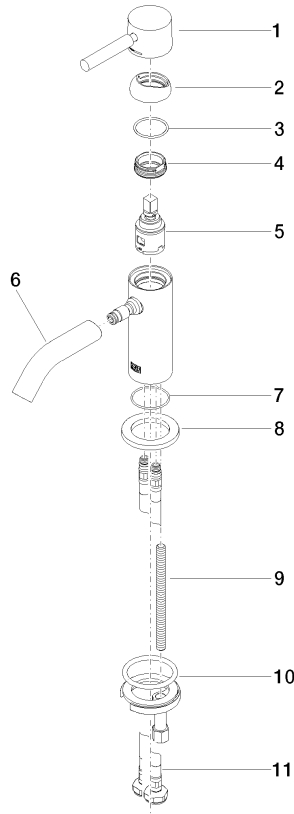



META Single-lever basin mixer without pop-up waste - Champagne (22kt Gold)

META

33 525 660

Spare parts list

Product version from 1/23/2020