





33 810 809



- 202mm projection
- pivotable spout 360°
- air-enriched flow
- max. flow 5.7 l/min at 3 bar flow pressure
- lead-free
- This product can help a building meet the requirements of Green Building Rating Systems, e.g. LEED®, BREEAM®, DGNB

Single-lever mixer for combining with rinsing/Profi spray only

	Champagne (22kt Gold)	33 810 809-47 0010
	Chrome	33 810 809-00 0010
	Brushed Platinum	33 810 809-06 0010
	Platinum	33 810 809-08 0010
	Durabronze (23kt Gold)	33 810 809-09 0010
	Dark Chrome	33 810 809-19 0010
	Brushed Durabronze (23kt Gold)	33 810 809-28 0010
	Matte Black	33 810 809-33 0010
	Brushed Champagne (22kt Gold)	33 810 809-46 0010
	Brushed Chrome	33 810 809-93 0010
	Brushed Dark Platinum	33 810 809-99 0010

Recommended miscellaneous



VAIA Rinsing spray set - Champagne (22kt Gold)

27 718 809-47

Recommended miscellaneous



VAIA Dispenser with rosette - Champagne (22kt Gold)

82 434 809-47

Recommended miscellaneous



VAIA AIR SWITCH Control button - Champagne (22kt Gold)

10 713 809-47



VAIA Single-lever mixer for rinsing/Profi spray - Champagne (22kt Gold)

VAIA

33 810 809

Flow rate chart

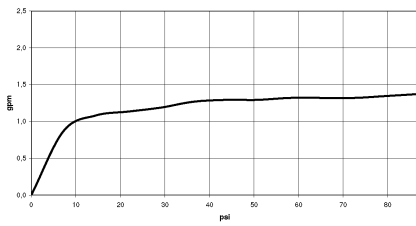

Codes & Standards

California Energy
Commission
(CEC)

33 810 809

Product version from 7/1/2023

Parts for other finishes can be found here: [Chrome](#)

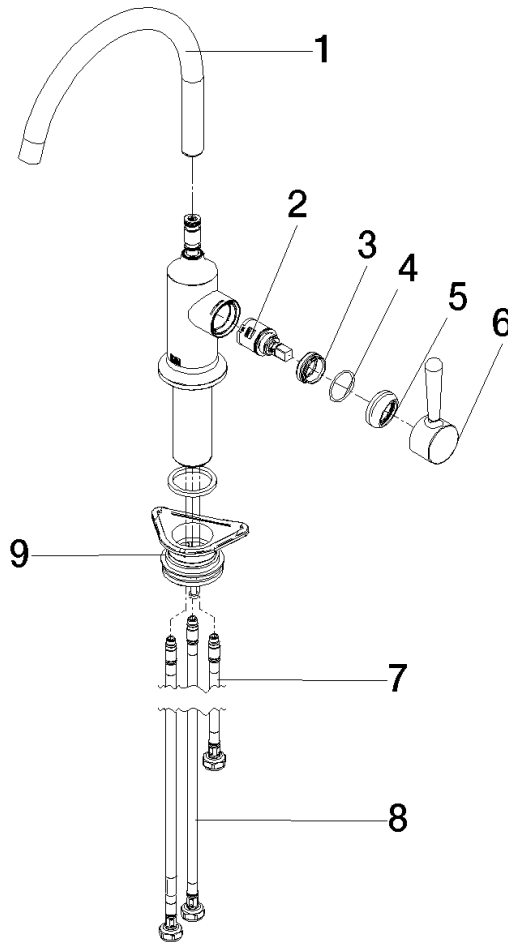



VAIA Single-lever mixer for rinsing/Profi spray - Champagne (22kt Gold)

VAIA

33 810 809

Spare parts list

Product version from 7/1/2023

No.	Item Number	Name	Quantity used	Delivery time
	90 28 22 313 00-47	spout	10	30