

**MEM Single-lever mixer - Chrome**

MEM

33 815 682



- 241mm projection
- pivotable spout 360°
- Optional swivel limiter available with swivel limiter set 12 820 970 90
- air-enriched flow
- height of mixer 382 mm
- height up to aerator 241 mm
- hole diameter 35 mm
- 2 x pressure hose with 3/8" cap nut
- max. flow 5.7 l/min at 3 bar flow pressure
- lead-free
- This product can help a building meet the requirements of Green Building Rating Systems, e.g. LEED®, BREEAM®, DGNB

Not possible in combination with rinsing spray.

	Chrome	33 815 682-00 0010
	Brushed Platinum	33 815 682-06 0010
	Platinum	33 815 682-08 0010
	Durabronze (23kt Gold)	33 815 682-09 0010
	Dark Chrome	33 815 682-19 0010
	Brushed Durabronze (23kt Gold)	33 815 682-28 0010
	Matte Black	33 815 682-33 0010
	Brushed Champagne (22kt Gold)	33 815 682-46 0010
	Champagne (22kt Gold)	33 815 682-47 0010
	Brushed Chrome	33 815 682-93 0010
	Brushed Dark Platinum	33 815 682-99 0010

**Recommended miscellaneous**

	<b>Swivel limitation set -</b>	12 820 970 90
---	--------------------------------	---------------

**Recommended miscellaneous**

	<b>AIR SWITCH Control button - Chrome</b>	10 713 970-00
---	---	---------------

**Recommended miscellaneous**

	<b>Dispenser without rosette - Chrome</b>	82 424 970-00
---	---	---------------

33 815 682

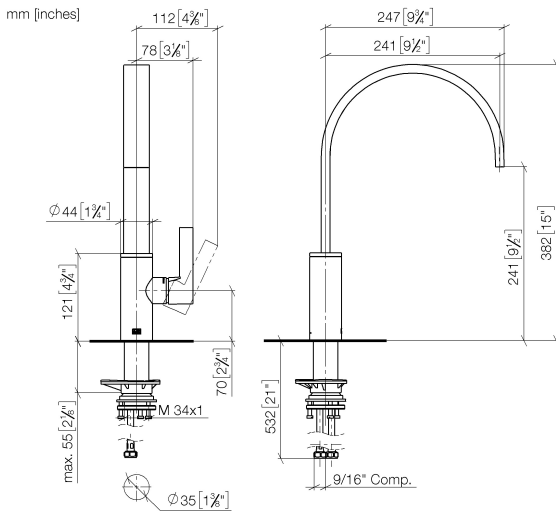

**Flow rate chart**

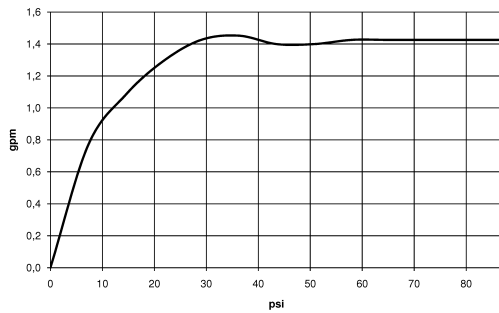

**Codes & Standards**

California Energy  
Commission  
(CEC)

33 815 682

Product version from 3/1/2023

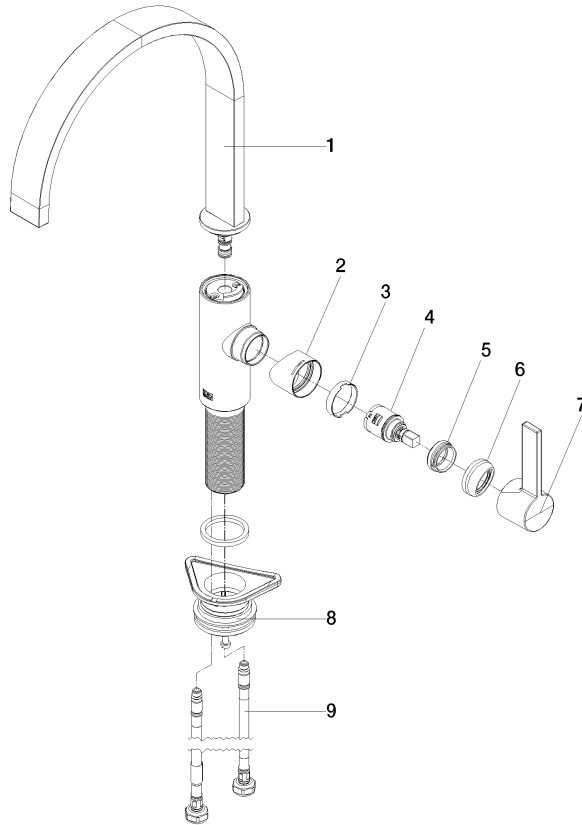



# MEM Single-lever mixer - Chrome

MEM

33 815 682

## Spare parts list

### Product version from 3/1/2023

No.	Item Number	Name	Quantity used	Delivery time
	90 28 22 333 01-00	spout	10	-

Spare part can no longer be ordered, please order the replacement item