









33 845 875



- 552mm projection
- pivotable spout 360°
- air-enriched flow
- height of mixer 372 mm
- height up to aerator 290 mm
- rosette 55 mm
- hole diameter 30 mm
- 2 x pressure hose with 3/8" cap nut
- max. flow 5.7 l/min at 3 bar flow pressure
- lead-free
- This product can help a building meet the requirements of Green Building Rating Systems, e.g. LEED®, BREEAM®, DGNB

Not possible in combination with rinsing spray.

	Champagne (22kt Gold)	33 845 875-47 0010
	Chrome	33 845 875-00 0010
	Brushed Platinum	33 845 875-06 0010
	Platinum	33 845 875-08 0010
	Durabrand (23kt Gold)	33 845 875-09 0010
	Dark Chrome	33 845 875-19 0010
	Brushed Durabrand (23kt Gold)	33 845 875-28 0010
	Brushed Champagne (22kt Gold)	33 845 875-46 0010
	Brushed Chrome	33 845 875-93 0010
	Brushed Dark Platinum	33 845 875-99 0010

Recommended miscellaneous

Dispenser with rosette - Champagne (22kt Gold) 82 444 970-47



Recommended miscellaneous

AIR SWITCH Control button - Champagne (22kt Gold) 10 713 970-47





TARA ULTRA PIVOT Single-lever mixer - Champagne (22kt Gold)

TARA ULTRA

33 845 875

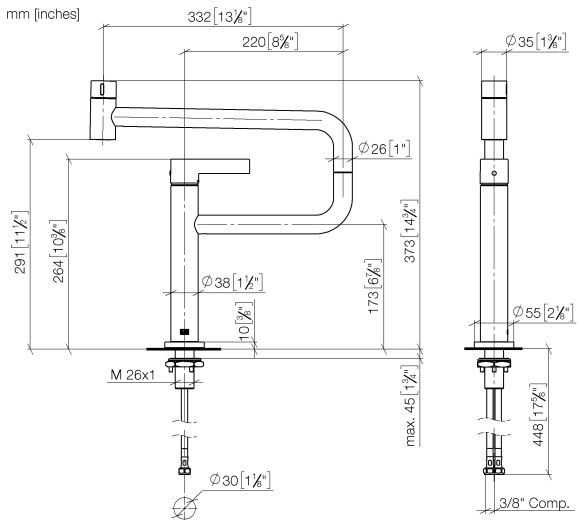

Flow rate chart

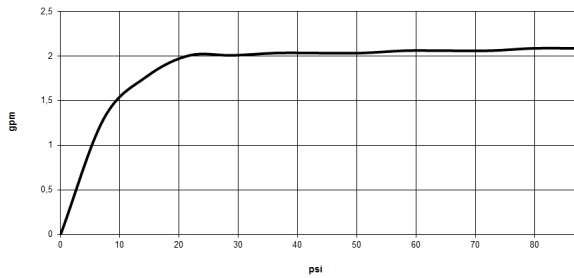

Codes & Standards

ADA	ASME A112.18.1/CSA B125.1	California Energy Commission (CEC)	NSF/ANSI 372
NSF/ANSI/CAN 61	NSF372	NSF61	



TARA ULTRA PIVOT Single-lever mixer - Champagne (22kt Gold)

TARA ULTRA

33 845 875

Certificates

IAPMO_6397

IAPMO_N-4976

33 845 875

Product version from 10/27/2020

Parts for other finishes can be found here: [Chrome](#)

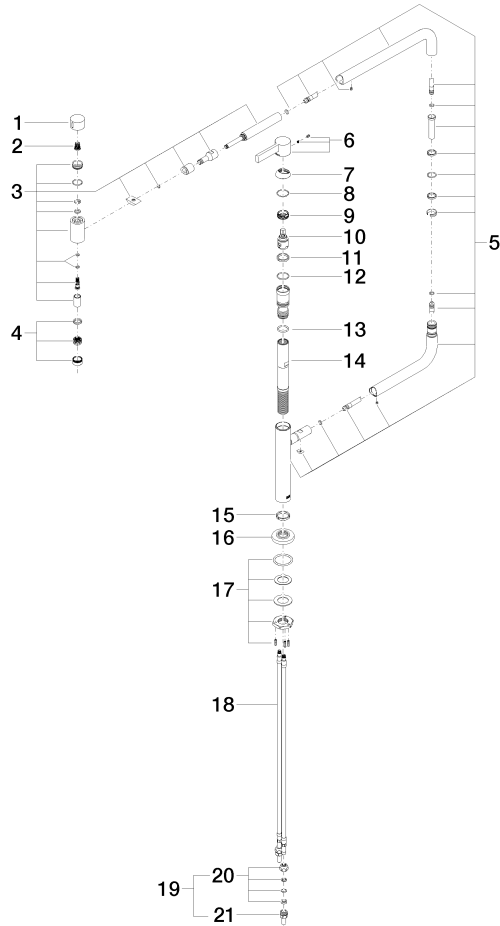



33 845 875

Spare parts list

Product version from 10/27/2020