







33 860 875



- 240mm projection
- pivotable 360°
- air-enriched flow and spray flow
- height of mixer 685 mm
- height up to aerator 129 mm
- hole diameter 35 mm
- 2 x pressure hose with 3/8" cap nut
- sprayface with anti-scaling system
- max. flow 5.7 l/min at 3 bar flow pressure
- lead-free
- This product can help a building meet the requirements of Green Building Rating Systems, e.g. LEED®, BREEAM®, DGNB

Intrinsic protection against back flow.

Switch back and forth between aerator and spray mode while water is running.

	Brushed Dark Platinum	33 860 875-99 0010
	Chrome	33 860 875-00 0010
	Brushed Platinum	33 860 875-06 0010
	Platinum	33 860 875-08 0010
	Dark Chrome	33 860 875-19 0010
	Brushed Chrome	33 860 875-93 0010

Recommended miscellaneous

**AIR SWITCH Control button -
Brushed Dark Platinum** 10 713 970-99



Recommended miscellaneous

**Dispenser without rosette -
Brushed Dark Platinum** 82 424 970-99



33 860 875

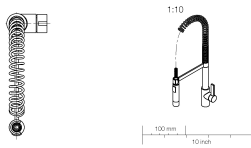
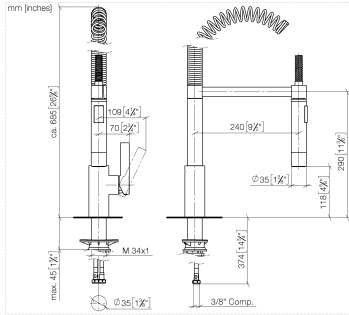

Flow rate chart



Codes & Standards

ADA

ASME
A112.18.1/CSA
B125.1

California Energy
Commission
(CEC)

NSF/ANSI 372

NSF/ANSI/CAN
61



TARA ULTRA Profi single-lever mixer - Brushed Dark Platinum

TARA ULTRA

33 860 875

Certificates

IAPMO_N-4976 (2). IAPMO_6397 (1).

33 860 875

Parts for other finishes can be found here: [Chrome](#)

