











33 870 809



- 240mm projection
- pivotable spout 360°
- Optional swivel limiter available with swivel limiter set 12 823 970 90
- air-enriched flow and spray flow
- height of mixer 416 mm
- height up to laminar flow regulator 228 mm
- hole diameter 35 mm
- 2 x pressure hose with 3/8" cap nut
- 1800 mm metal shower hose
- sprayface with anti-scaling system
- max. flow 5.7 l/min at 3 bar flow pressure
- lead-free
- This product can help a building meet the requirements of Green Building Rating Systems, e.g. LEED®, BREEAM®, DGNB

Intrinsic protection against back flow.

Switch back and forth between aerator and spray mode while water is running.

	Chrome	33 870 809-00 0010
	Brushed Platinum	33 870 809-06 0010
	Platinum	33 870 809-08 0010
	Durabrace (23kt Gold)	33 870 809-09 0010
	Dark Chrome	33 870 809-19 0010
	Brushed Durabrace (23kt Gold)	33 870 809-28 0010
	Matte Black	33 870 809-33 0010
	Brushed Champagne (22kt Gold)	33 870 809-46 0010
	Champagne (22kt Gold)	33 870 809-47 0010
	Brushed Chrome	33 870 809-93 0010
	Brushed Dark Platinum	33 870 809-99 0010

Recommended miscellaneous

Swivel limitation set -

12 823 970 90



Recommended miscellaneous

VAIA Dispenser with rosette -  
Chrome

82 434 809-00



Recommended miscellaneous

VAIA AIR SWITCH Control button - 10 713 809-00  
Chrome



33 870 809

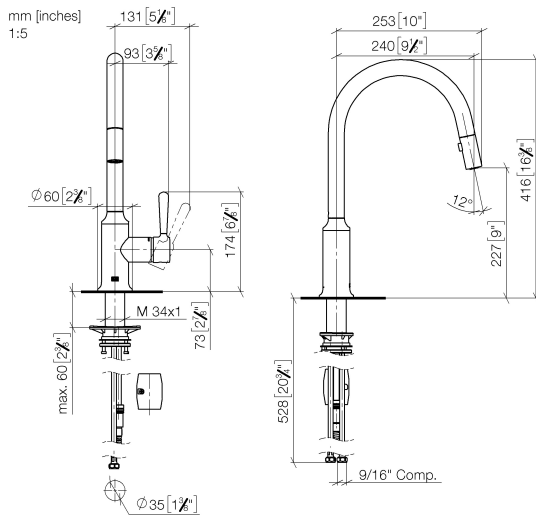

Flow rate chart



Codes & Standards

California Energy  
Commission  
(CEC)

33 870 809



Spare parts list

No.	Item Number	Name	Quantity used	Delivery time
1	90 28 22 397 00-00	spout	1	10
2	90 15 05 064 05 90	cartridge	1	2
3	09 14 10 190 90	seal	1	2
4	09 28 30 030-00	cover	1	10
5	90 20 80 052 00-00	handle	1	10
6	04 28 20 067 00 90	pipe	1	2
7	90 24 03 253 01 90	adaptor	1	2
8	04 30 02 120 00-00	hose	1	10
9	04 21 50 010 00 90	accessories	1	2
10	04 30 04 103 00 90	hose	2	2
11	04 30 11 040 00 90	fixing set	1	2
12	90 18 40 317 00-00	shower	1	10