

33 870 895



- 240mm projection
- pivotable spout 360°
- Optional swivel limiter available with swivel limiter set 12 821 970 90
- laminar and spray flow
- height of mixer 444 mm
- height up to laminar flow regulator 240 mm
- hole diameter 35 mm
- 2 x pressure hose with 3/8" cap nut
- 1800 mm metal shower hose
- sprayface with anti-scaling system
- max. flow 5.7 l/min at 3 bar flow pressure
- lead-free
- This product can help a building meet the requirements of Green Building Rating Systems, e.g. LEED®, BREEAM®, DGNB

Intrinsic protection against back flow.

Push button locks into spray mode when pressed. To switch back to laminar flow the water must be turned off.

	Matte Black	33 870 895-33 0010
	Chrome	33 870 895-00 0010
	Brushed Platinum	33 870 895-06 0010
	Platinum	33 870 895-08 0010
	Durabronze (23kt Gold)	33 870 895-09 0010
	Dark Chrome	33 870 895-19 0010
	Brushed Durabronze (23kt Gold)	33 870 895-28 0010
	Brushed Champagne (22kt Gold)	33 870 895-46 0010
	Champagne (22kt Gold)	33 870 895-47 0010
	Brushed Chrome	33 870 895-93 0010
	Brushed Dark Platinum	33 870 895-99 0010

Recommended miscellaneous

	<b>Swivel limitation set -</b>	12 821 970 90
---	--------------------------------	---------------

Recommended miscellaneous

	<b>Dispenser without rosette - Matte Black</b>	82 424 970-33
---	--	---------------

Recommended miscellaneous

	<b>AIR SWITCH Control button - Matte Black</b>	10 713 970-33
---	--	---------------

Recommended miscellaneous

	<b>Dispenser without rosette - Matte Black</b>	82 424 970-33
---	--	---------------

Recommended miscellaneous

	<b>AIR SWITCH Control button - Matte Black</b>	10 713 970-33
---	--	---------------

33 870 895

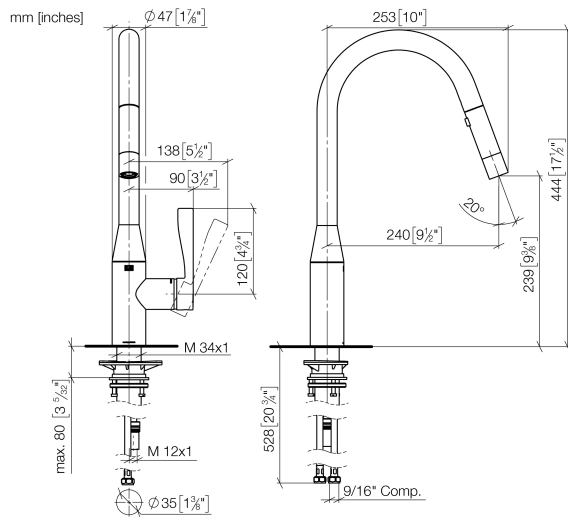

**Flow rate chart**

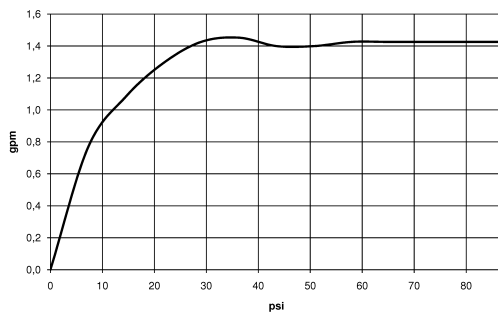

**Codes & Standards**

ADA

ASME  
A112.18.1/CSA  
B125.1

California Energy  
Commission  
(CEC)

NSF/ANSI 372

NSF/ANSI/CAN  
61



## SYNC Single-lever mixer Pull-down with spray function - Matte Black

---

SYNC

33 870 895

### Certificates

---

IAPMO\_N-4976 (2). IAPMO\_6397 (1).

33 870 895

