







33 880 888 Product version from 5/3/2021



- 200mm projection
- pivotable spout 360°
- air-enriched flow and spray flow
- height of mixer 415 mm
- test
- height up to aerator 275 mm
- hole diameter 35 mm
- 2 x pressure hose with 3/8" cap nut
- sprayface with anti-scaling system
- max. flow 5.7 l/min at 3 bar flow pressure
- lead-free
- This product can help a building meet the requirements of Green Building Rating Systems, e.g. LEED®, BREEAM®, DGNB

Intrinsic protection against back flow.

| | | |
|---|-----------------------|--------------------|
|  | Chrome | 33 880 888-00 0010 |
|  | Brushed Platinum | 33 880 888-06 0010 |
|  | Platinum | 33 880 888-08 0010 |
|  | Dark Chrome | 33 880 888-19 0010 |
|  | Brushed Bronze | 33 880 888-42 0010 |
|  | Brushed Chrome | 33 880 888-93 0010 |
|  | Brushed Dark Platinum | 33 880 888-99 0010 |

Recommended miscellaneous

AIR SWITCH Control button - Chrome 10 713 970-00



Recommended miscellaneous

Dispenser with rosette - Chrome 82 444 970-00



33 880 888 Product version from 5/3/2021

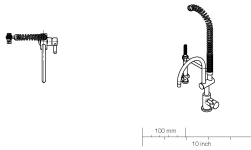
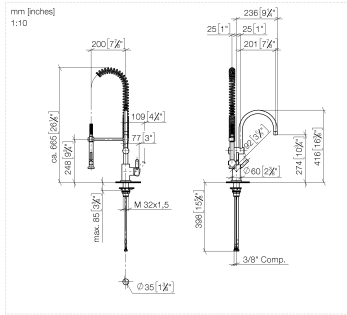

Flow rate chart

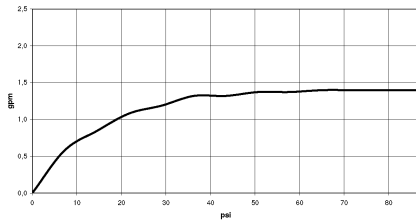

Codes & Standards

ADA

ASME
A112.18.1/CSA
B125.1

California Energy
Commission
(CEC)

NSF/ANSI 372

NSF/ANSI/CAN
61

NSF372

NSF61



TARA Profi single-lever mixer - Chrome

TARA

33 880 888 Product version from 5/3/2021

Certificates

IAPMO_N-4976

IAPMO_6397

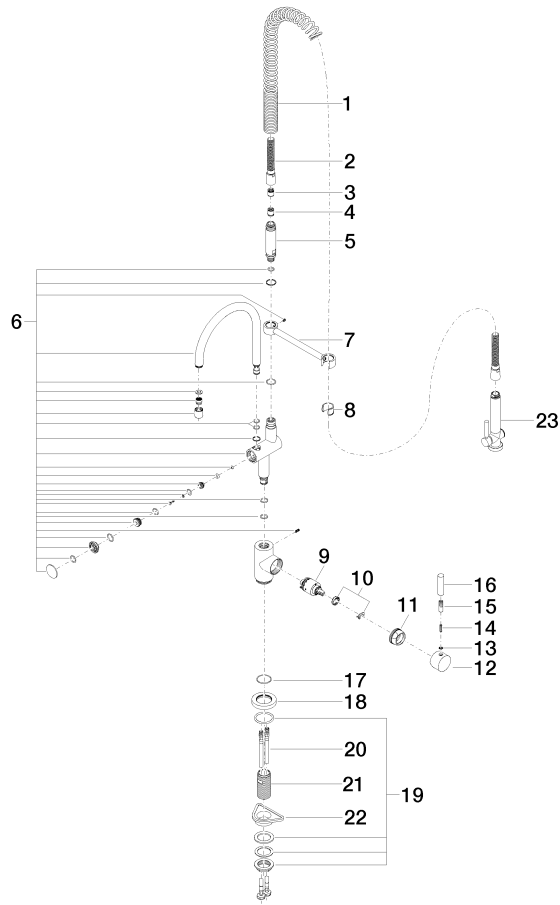

Spare parts list

| No. | Item Number | Name | Quantity used | Delivery time |
|-----|--------------------|---------------------|---------------|---------------|
| 1 | 09 16 02 034 90 | spring | 1 | 2 |
| 2 | 90 30 02 065 00-00 | hose | 1 | 10 |
| 3 | 09 23 01 047 90 | back-flow preventer | 1 | 2 |
| 4 | 90 23 01 141 00 90 | back-flow preventer | 1 | 2 |
| 5 | 09 30 01 067 10-00 | adaptor | 1 | 10 |
| 6 | 90 19 88 019 01-00 | spout | 1 | 10 |
| 7 | 04 17 20 014 00-00 | holder | 1 | 10 |
| 8 | 90 18 40 035 00 90 | sleeve | 1 | 2 |
| 9 | 90 15 05 065 00 90 | cartridge | 1 | 2 |
| 10 | 90 28 10 148 00 90 | accessories | 1 | 2 |
| 11 | 09 24 04 107-00 | nut | 1 | 10 |
| 12 | 90 20 88 040 00-00 | handle | 1 | 10 |
| 13 | 90 30 11 032 00 90 | disc | 1 | 2 |
| 14 | 09 31 11 010 90 | pin | 1 | 2 |
| 15 | 90 24 04 048 00-00 | nipple | 1 | 10 |
| 16 | 09 20 62 005-00 | handle | 1 | 10 |
| 17 | 09 14 10 102 90 | seal | 1 | 2 |
| 18 | 09 28 10 055-00 | rosette | 1 | 10 |
| 19 | 04 23 10 009 02 90 | fixing set | 1 | 2 |
| 20 | 04 30 04 107 00 90 | hose | 2 | 2 |
| 21 | 09 30 01 010 90 | adaptor | 1 | 2 |
| 22 | 09 18 40 090 90 | sleeve | 1 | 2 |
| 23 | 90 12 11 097 11-00 | shower | 1 | 10 |